

 **Netti**[®] III

 **Netti**[®] III HD

User manual



CE This product conforms to regulation
(EU) 2017/745 for medical products.

UM0028UK 2025-03

*inspire
joy of life*

CONTENT

1. INTRODUCTION	4
1.1 AREAS OF USE/INDICATIONS FOR NETTI III AND NETTI III HD	5
1.2 CONTRA INDICATIONS	5
1.3 QUALITY AND DURABILITY	5
1.4 THE ENVIRONMENT AND WASTE DISPOSAL	6
1.5 INFORMATION FOR RE-USE	6
1.6 ABOUT THIS MANUAL	7
1.7 VITAL MEASURES	7
2. QUICK REFERENCE	9
3. DESCRIPTION*	10
4. FEATURES OF NETTI III & NETTI III HD	11
5. ACCESSORIES	12
5.1 MOUNTING OF HIP BELT	15
5.2 MOUNTING OF H-BELT BAR	16
5.3 ELECTRICAL COMPONENTS	16
5.4 NETTI DYNAMIC SYSTEM KIT	17
6. ASSEMBLING AND ADJUSTING	19
6.1 UNPACKING (SEE CHAPTER 5 & 6)	19
6.2 DRIVE WHEELS	20
6.3 FRONT FORK	20
6.4 FRONT CASTORS	20
6.5 SEAT HEIGHT AT THE FRONT	21
6.6 SEAT HEIGHT AT THE REAR	21
6.7 BACK REST	21
6.8 ADJUSTING THE SEAT DEPTH	22
6.9 ADJUSTING SEAT DEPTH AT THE FRONT	23
6.10 ANTI-TIP	24
6.11 ADJUSTING ARM SUPPORTS	24
6.12 CUSHIONS	25
6.13 ADJUSTING THE VELCRO BACK	25
6.14 LEG SUPPORTS	25
6.15 HEAD SUPPORT	31
6.16 PUSH HANDLES	32
6.17 ADJUSTING THE BRAKES	32

7.	SEAT ANGLE / TILT AND BACK ANGLE / RECLINE	34
7.1	SEAT ANGLE	34
7.2	BACKREST ANGLE	34
7.3	KEY WORDS REGARDING TILT AND RECLINE OF STATIC COMFORT WHEELCHAIRS, AND COMMON FEATURES OF DYNAMIC WHEELCHAIRS	34
7.4	DECREASE THE POSSIBILITY OF SLIDING, SHEAR AND PRESSURE SORES:	35
7.5	OPERATING TILT HANDLE: TILTING THE SEATING UNIT	35
7.6	OPERATING RECLINE HANDLE: RECLINING THE CHAIR BACK	36
8.	TRANSPORT	36
8.1	TRANSPORT IN CAR	36
8.2	TRANSPORT IN AIR-PLANE	38
8.3	TRAVELLING BY PUBLIC TRANSPORT	38
8.4	FOLDING FOR TRANSPORT	38
9.	MANOEUVRING	39
9.1	GENERAL TECHNIQUES	39
9.2	DRIVING TECHNIQUES – STEP UP –	39
9.3	DRIVING TECHNIQUES – STEP DOWN –	40
9.4	DRIVING TECHNIQUES – SLOPE –	40
9.5	DRIVING TECHNIQUES – UP STAIRS –	41
9.6	DRIVING TECHNIQUES – DOWN STAIRS –	41
9.7	TRANSFER	42
9.8	POINT OF BALANCE	43
9.9	LIFTING THE WHEELCHAIR	43
9.10	PUSH RIM	43
10.	MAINTENANCE	44
10.1	MAINTENANCE INSTRUCTIONS	44
10.2	CLEANING AND WASHING	44
10.3	LONG TERM STORING	45
11.	TROUBLESHOOTING	46
12.	TESTS & WARRANTY	47
12.1	TESTS	47
12.2	WARRANTY	47
12.3	CLAIM	47
12.4	NETTI CUSTOMIZED / INDIVIDUAL ADAPTATIONS	48
12.5	COMBINATIONS WITH OTHER PRODUCTS	48
12.6	SERVICE AND REPAIR	48
13.	MEASUREMENTS & WEIGHT	49

1. INTRODUCTION



Netti III and Netti III HD are comfort wheelchairs meant for both indoor and outdoor use. It is tested to DIN EN 12183:2014. The tests were carried out by an accredited test laboratory in Germany.

In Alu Rehab we believe that wheelchairs should be chosen based on a thorough assessment focusing on the needs of the user and demands from the environment.

It is therefore important to know about the possibilities and restrictions of the wheelchair. Netti III is a wheelchair designed for users with the need for comfort and relief. The combination between the seating system and the ergonomic solutions in the frame construction, offers many possibilities for adaptation and adjustments and possibilities to vary the sitting position from activity to rest using tilt and recline functions.

Netti III is available in 2 versions:

- Netti III with seat widths from 350-500 mm
- Netti III HD for hard use and heavier loads - with seat widths from 350 - 600 mm.

Max user weight:

- Netti III - 135 kg
- Netti III HD - 160 kg

Netti III and Netti III HD have been crash tested at RISE (Research Institute of Sweden) and TÜV Rheinland according to ISO 7176-19 and is approved for being used as a seat in a car.



When mounting accessories such as power kit etc, the weight of the accessories must be subtracted from the max user weight.



Specifications varies between countries.

1.1 AREAS OF USE/INDICATIONS FOR NETTI III AND NETTI III HD

Netti III is a multi-functional wheelchair for wheeled transport for partially or fully immobile adolescent and grown up persons with physical and/or mental disabilities. It provides a means by which a disabled person who requires the possibility to vary the sitting position from activity to rest will profit from using tilt and recline functions. It is designed for users with the need for comfort and relief. The combination between the seating system and the ergonomic solution in the frame construction offers many possibilities for adaptation and adjustments.

The disabilities may have multiple causes. Netti III has an adjustable seat and back angle, thus facilitating for the user change of position, mobilization or posture correction (stabilization), wherever the following functional impediments with their multiple possible causes are present:

- limited or lacking mobility
- limited or lacking muscle power
- limited movement range
- lacking or limited trunk and body stability
- hemiplegia
- rheumatic-type disorders
- craniocerebral injuries
- amputations
- other neurological or geriatric disorders.



If our standard solutions does not cover you needs, please contact our customer service for Netti customized solutions.

1.2 CONTRA INDICATIONS

With strongly muscular spasticity and involuntary movements we recommend the Netti Dynamic System which offers a frame construction that follows the movement pattern of the user. Ignoring this advice could in unfavourable circumstances lead to the deformation or fracture of metal parts in the area of the back tube, the leg rests or the arm rests.

1.3 QUALITY AND DURABILITY

The Netti III wheelchair is tested at an accredited test laboratory in Germany, following the European Standard DIN EN 12183.

As manufacturer, Alu Rehab A.S evaluates the test to be equal to 5-6 years of normal use of the chair. The disability of the user, the toughness of use as well as the level of maintenance done foremost decides the durability of the wheelchair. Thus, the durability will vary depending on these three factors. With adequate maintenance, the lifetime of the wheelchair can be expected to exceed the 5 year warranty period by many years.

1.4 THE ENVIRONMENT AND WASTE DISPOSAL



Alu Rehab and its suppliers wish to protect the environment.

This means:

- That we avoid using environmentally harmful substances and processes to the greatest extent possible.
- That Alu Rehab's products are ensured a long service life and a high degree of flexibility - to benefit the environment and economy.
- That all packaging can be recycled.
- That the wheelchair was designed to be separated into its component materials - to make recycling easier.

 **Contact your local recycling agent to get correct information how to handle in your area.**

 **TEMPERATURE RANGE**
Netti III wheelchair is designed for temperature range of -10°C to +40°C

1.5 INFORMATION FOR RE-USE

All products from Alu Rehab are designed to give years of maintenance-free service. All products can be adapted for re-use by an authorised dealer. In order to guarantee performance and safety, Alu Rehab recommends the following tests prior to any re-use.

Please examine the following components for function, integrity etc. and replace parts if necessary:

- Wheels (tyre tread)
- Wheelchair frame
- Front castors and quick release
- Hubs
- Brake function
- Directional stability of wheels
- Bearings: test for wear and lubrication.
- Cushions
- Leg supports
- Arm supports
- Recline/tilt function
- Push bar / handles
- Anti tip

For hygienic reasons: please replace the head support for a new user.

Please also note the contents of Section 10.2 Cleaning and care.

ANTI-TIP

Correctly fitted, the anti-tip will secure the chair from tipping backwards.

We strongly recommend the use of the anti-tips.

Latest user manual updates, product safety notes, addresses and other product information like recalls etc. will be published on our web page.

1.6 ABOUT THIS MANUAL

In order to avoid damages while using the Netti III wheelchair, please read this manual carefully before starting to use the chair.



Symbol of forbidden actions.
No warranty can be claimed whenever these actions are implemented.



Symbol of warning.
Whenever this symbol is used, caution has to be taken.



Symbol for important information.



Symbol for useful tips.



Symbol for tools.



Symbol for:
Max safe slope for hand brake.



Symbol for: Max user weight.



Symbol for medical device



Manufacturer: name + address



Date of manufacturing



Product serial number



Read Instruction



Please note that this manual is updated according to the year and date stated on each page.

User Manual on web

For enhanced readability (advantageous for users with visibility challenges) please find our user manual on our web page: www.My-Netti.com - manuals - user manual Netti III.

1.7 VITAL MEASURES

Netti III is a comfort wheelchair designed for both outdoor and indoor use.
Min. dimensions in table refer to seat width 350 mm.
Max dim refers to seat width 600 mm.



Specifications varies between countries.

TOTAL WEIGHT: 33 KG
(450 mm width chair)

SEAT WIDTH:
350, 380, 400, 430,
450, 500, 550 & 600 mm



SEAT DEPTH:
(From back rest cushion to front of seat plate)
400, 425, 450, 475, 500 mm



SEAT HEIGHT:
(From floor to top seat plate using 24" main wheels in upper hole position).
440 mm*

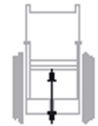

* By changing position of main wheels, it is possible to achieve seat height of 475 mm. Other seating heights can be reached by changing wheel dimensions.

BACKREST HEIGHT:
500 mm*



* Using back rest extender gives 600 mm including back cushion.

** For Netti III with seat width 500 mm and more, the overall width exceeds recommended 700 mm.

*** Least stable and most stable refers to the positioning of the anti-tippers. Always use anti-tippers driving uphill.

Specification	min.	max.
Overall length with leg rest - horizontal seat. (Seat + back tilted max forward. Leg supports vertical)	1030 mm (955 mm)	1030
Overall width **	570 mm	820
Folded length	780 mm	780
Folded width (removed wheels)	480 mm	730
Folded height (removed wheels, cushions, arm-, head- + leg-support)	520 mm	520
Total mass	32,0 kg	36,0 kg
Mass heaviest part: frame	17,0 kg	20,2 kg
Mass heaviest component: leg support	2,4 kg	3,0 kg
Static stability downhill		13°
Static stability uphill***	8°	15°
Static stability sideways	15°	15°
Safe slope, use anti-tipper		10°
Seat plane angle	-9°	16°
Effective seat depth	400 mm	500 mm
Effective seat width	350 mm	600 mm
Comfort Seat surface height at front	440 mm	475 mm
Backrest angle	86°	133°
Backrest height ex cushion	490 mm	590 mm
Leg support to seat distance	280 mm	560 mm
Leg to seat surface angle	90°	180°
Arm support to seat distance	185 mm	325 mm
Front location of arm support structure	300 mm	430 mm
Push rim diameter	535 mm	535 mm
Horizontal axle location	-10 mm	95 mm
Parking brake Max slope	-	7°
Minimum turning radius, vertical leg supports	R 675 mm	R 702 mm

Model with 24" main wheels. Measured without cushions.

2. QUICK REFERENCE

The content of this page is a summary of the whole manual. It gives you a brief introduction to the use and care of the Netti III wheelchair.

 **The quick reference is not a replacement for the manual, only reminder/check list.**

- Unpack the wheelchair (Chapter 6.1).
- Mount the main wheels (Chapter 6.2).
- Mount the front castors (Chapter 6.4).
- Rise the back rest and mount the recline gas strut to the back rest using the locking bolt. (Chapter 6.7).
- Mount the arm supports (Chapter 6.11).
- Mount the cushions (Chapter 6.12).
- Mount the leg supports (Chapter 6.14).
- Adjust the push handles (Chapter 6.16).
- Mount the head support (Chapter 6.15).
- Mount accessory (See chapter 5. for more information. Mounting descriptions will follow the accessory.)

 **ADJUST THE WHEELCHAIR TO THE USER:**

Adjust seat depth and eventually the wheelchair balance, foot board height, armrest height, head support height and depth, chair back cushion height.

For more information about adapting the wheelchair to the user please see

www.My-Netti.com knowledge and tools.

 For troubleshooting, see chapter 11.
For adjustments see chapters 6.

 **Announcements to product safety and eventually product recalls will be published on our home page www.My-Netti.com**

 For visually impaired people, manuals and catalogues can be downloaded at www.My-Netti.com

 **Product configuration may vary between different countries. Illustrations may differ from the delivered product.**

 **Drive carefully!**

 **Always used the anti-tips, they are for the safety of the user.**

 **The brakes must always be used when leaving the user in the backwards tilted position.**

 **Be sure to lock all handles properly.**

 **Never stand on the foot plates due to risk of tipping forwards.**

 **Never lift the wheelchair by the leg supports, arm supports or head support.**

 **Watch out for pinching danger when folding and unfolding, tilting, reclining and all other adjustment movements.**

 **Be aware that friction against push-rims can create a warm surface.**

 **Surface temperature of metal parts in frame structure might increase when exposed to direct sunlight.**

 **Salt water can increase risk of corrosion. Further precautions related to environmental conditions not needed.**

 **If electrical functions are mounted:
Charge the battery daily.**

 **If the chair has pneumatic tires:
Make sure to check tyre pressure every week and inflate to keep 24" at 45 PSI, and 7" at 36 PSI**

 **If in doubt – contact your dealer!**

3. DESCRIPTION*

1. Head support
2. Back rest cushion - model Stabil
3. Arm support with pad
4. Seat cushion
5. Knee pad
6. Calf support bracket
7. Bearing house/front fork fastening
8. Quick release for front fork
9. Front fork
10. Front castors
11. Locking bolt for foot plates
12. Foot plate
13. Calf support
14. Angle adjustment screw
15. Height adjustment screw
16. Angle adjustment knob
18. Anti-tip
19. Brake
20. Quick release axle
21. Push ring
22. Main wheel
23. Name plate Wheelchair on lower back cross bar.
24. Release handle for arm support
25. Release handle for push handles
26. Push handle

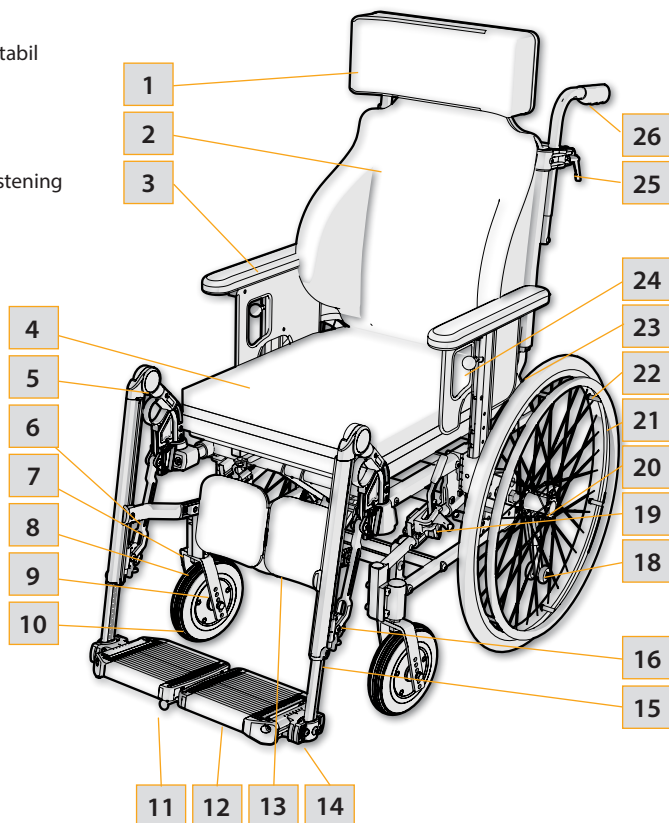

* Be aware that specifications may vary between countries.



If any of these parts are missing, please contact your dealer.



For complete information, please contact your dealer.

Netti III and Netti III HD are identical chairs except for the tilt cylinder and armrest pads.
 Netti III has only one tilt cylinder, Netti III HD has 2 tilt cylinders.
 Netti III HD has wider armrest pads.

4. FEATURES OF NETTI III & NETTI III HD

STANDARD

SEAT - NETTI UNO SEAT

- Cushion with good pressure distributing properties.
 - Tilt -9° to +16°.
 - Adjustable height 400 mm to 485 mm by change of wheel size and position.
 - Adjustable depth of 100 mm.
 - Seat plate: Comfort seat plate.
- From seat with 500 mm: solid seat plate.

WHEELS*

- 24" x 1" Puncture proof main wheels with quick release axle.
- Push rim: Aluminium.
- 7" Puncture proof front castors with quick release axle.

Standard main wheels may vary between countries.

PUSH HANDLES

- Height adjustable, swingable, removable.

BRAKES - NETTI III - USER BRAKES

Netti III HD User brakes + drum brakes.

ANTI-TIP

- Height and length adjustable - swingable.

BACK REST - NETTI SMART

- Angle: 88° - 130°.
- Height: 500 mm.
- Back rest cushion with integrated lumbar support and side support, height adjustable.
- Height adjustable and removable push handles.

LEG SUPPORT

- Netti III Angle adjustable.
- Netti III HD: Grandis.
- Height- and angle adjustable foot plates with calf supports and knee upholstery.

ARM SUPPORT

- Height adjustable and removable.
- Depth adjustable pads.

HEAD SUPPORT

- Height, depth and angle adjustable.
- Removable.

OPTIONS /ACCESSORIES

SEAT

- Sliding seat (See chapter 5).
- Trays & reading stand for trays (See chapter 5).
- Hip belts and 4 point belts (See chapter 5).

WHEELS

- Puncture proof wheels (See chapter 5).
- Pneumatic wheels (See chapter 5).
- Wheels with drum brake (See chapter 5).
- Wheels with one hand drive (See chapter 5).
- Camber angle: 2° or 4°.
- Pneumatic front castors (See chapter 5).
- Spoke protectors (See chapter 5).
- Push rims (See chapter 5).

BRAKES - DRUM BRAKES

BACK REST

- Back rest extender (See chapter 5).
- Lumbar support and Wedge (See chapter 5).
- Back rest cushions - different models.

LEG SUPPORT

- Universal leg support.
- Amputation support.
- Knee and thigh support (See chapter 5).

ARM SUPPORT

- Different pads (See chapter 5).
- Hemi armrest and Hemi cushion (See chapter 5).

HEAD SUPPORT

- Different models (See chapter 5).

5. ACCESSORIES

The anytime updated complete accessory program is found on our web page www.My-Netti.com – order forms.

BELTS

Several models:
Hip belts with or without upholstery and with plastic lock or car lock. (See chapter 5.1 for mounting.)



H-BELT ATTACHMENT BAR

To be mounted onto separate bars or to the push handles. Comes in two sizes with telescopic bar. (See chapter 5.2)



TRAYS

3 models:
Swingable, lockable and standard "push on" model.



UPHOLSTERY FOR TRAY

Offers a soft base for the arm resting on the tray.



HALF TRAY

Swingable upholstered half tray. The tray replaces the existing standard armrest.



WEDGE

Increases side support.



LUMBAR SUPPORT

Increases lumbar curvature.



BRAKE EXTENDERS

90 mm
120 mm
250 mm



SITWEDGE

Pelvic stabilizer.



SEAT CUSHIONS

Many to choose from.
Please contact your dealer.



BACK REST CUSHIONS

Many to choose from.
Please contact your dealer.



SPOKE PROTECTORS

For 20", 22" and 24". Black or transparent is optional.



FOOT BOX

Upholstered



LEG SUPPORTS

Angle adjustable



GRANDIS

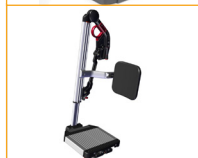

UNIVERSAL

Adjustable in fixed positions between 33° to 105° using an adjustment wheel.



AMPUTATION SUPPORT



FOOT PLATE UPHOLSTERY



KNEE / THIGH SUPPORT

The support reduces adduction.



ABDUCTION BLOCK

The block reduces abduction.

Small: 80 mm width
Medium 110 mm width
Large: 140 mm width



HEAD SUPPORTS

Support A

Side support also available with forehead strap.

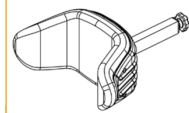

Support B

Small

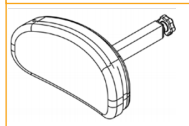

Support C

Large

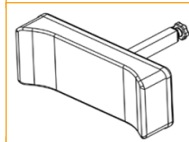

Support D

comfort pressure distributive

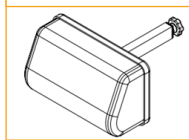

Support E

adjustable side supports



Support F

with cheek / chin support band



HYGIENE COVER

Protects the core of the head support.



HEAD CUSHION

400 x 400 mm cushion with Kospoflex filling and rubber.



HEAD CUSHION COMFORT

Cushion with Kospoflex filling to pull onto head rest.



BACK REST EXTENDER

120 mm extender.

To be used together with 600 mm back rest cushion. When using Netti III with seat width 500 mm and more as seat in car, the back rest extender and enforced head support is required.



ARM SUPPORT PADS

Wide: 415 x 80 mm
Long: 445 x 70 mm
Long/Wide: 525 x 80 mm
Short: 333 x 58 mm
Standard: 385 x 58 mm
Arm support pad bended



HEMI ARM SUPPORT

Offers extra support for the affected arm. Can be set in fixed positions.



HEMI CUSHION

A more accommodating support than the hemi arm support.



COMFORT PADS

To be attached to the skirt guard. Offers a pressure distributing effect. 25 mm, 35 mm and 45 mm.



SLIDING SEAT

The seat can be pulled out and pushed in while the user sits in the seat. This eases transfer and positioning of the user. NOT to be used for seat depth extension.

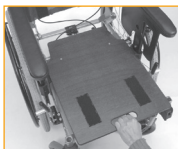

COMFORT PLATE

The plate has a net covered hole in the rear, which in cooperation with the seat cushion, increases pelvic stabilization.

Seat plate extender 45 mm to be mounted to the leg support extensions pieces. They are attached to the frame when not in use.

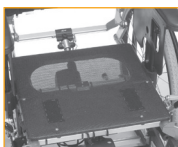

CALF PAD HINGED

The user doesn't have to lift the legs when mounting or dismounting the leg supports.



FOOT BOARD WITH LOCK

The leg supports can be swung to the side like standard leg supports.



SIDE SUPPORT CORRECTION

Meant for correction of bad postures in the upper trunk. For optimal function use together with flip backrest.



PAD FOR SIDE SUPPORT CORRECTION



SIDE SUPPORT STABLE

Meant for users with decreased stability of the upper trunk. For optimal function use together with Stable cushion.



PAD FOR SIDE SUPPORT STABLE



LONG BACK REST HINGE

Covers seat depth: 545, 570 and 590 mm. Must be used with extra long locking head.



EL. COMPONENTS

For tilt, back rest and leg supports, separate or complete. Please see Netti III El at My-Netti.com for detailed information.

FRAME EXTENDER

Increases distance between main wheels and front castors. Reduces tipping risk.



UPHOLSTERY FOR CALF SUPPORT BRACKET

Reduces pressure.



TOOL SET



MAIN WHEELS

available in sizes: 12", 16", 20", 22", 24" & 26". All wheels available 2 widths: 1" and 1 3/8". Puncture proof Flexel or PU or pneumatic. Inflation pressure is clearly marked on pneumatic tyres.



PUSH RIMS ALUMINIUM:

20", 22", 24", 26"

FRICION PUSH RIM

20", 22", 24", 26"

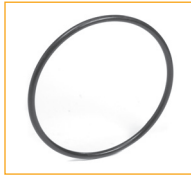

ONE HAND DRIVE

20", 22", 24", 26"x1 3/8" 20", 22", 24" x 1"

In addition you must order a telescopic connection bar for the wheels.



FRONT CASTORS

Sizes available:

3", 4", 5", 6", 7" & 8". Castor available in Flexel or PU puncture proof qualities or pneumatic.



FRONT FORKS

Standard w / axle

Long w / axle

Short w / axle

Wide w / axle

Long /Wide w / axle



CAR FIXING BRACKET

For fixing the wheelchair in a vehicle. To be fixed to the main wheel bracket.

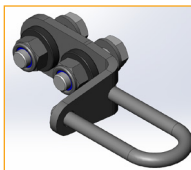

5.1 MOUNTING OF HIP BELT

Please see www.My-Netti.com for continuously updated overview of belts and harnesses and installation instructions.

- Pull the belt through the hole in the hip belt bracket.

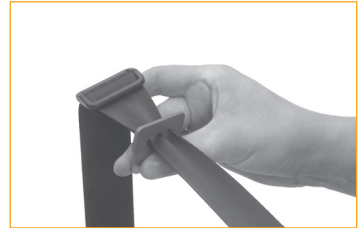

- Thread the belt back through the belt clamp.



- Fix the hip belt bracket to the rearmost hole in the back hinge, using the enclosed screws and nuts.



-  2 pcs 13 mm open-end spanner.

5.2 MOUNTING OF H-BELT BAR

- See separate mounting description MD0074 for Harness adapter kits.
- Fix the push handles in correct position and lock firmly. Then fix the bar at the right position / height. The height should be level with the shoulders of the user.

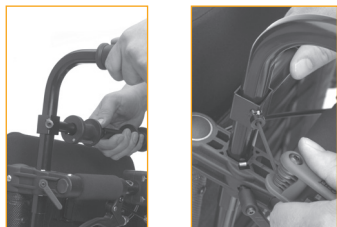

- Thread the belt through the rolls and lock the belt by pulling the belt through the belt clamp. Adjust to the requested length of belt.

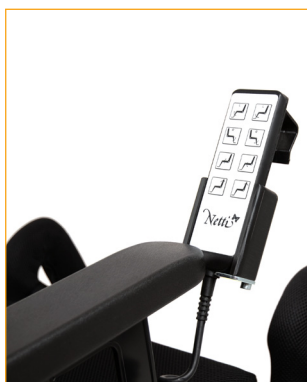

5.3 ELECTRICAL COMPONENTS

Netti III EL is a wheelchair equipped with electrical operation of tilt, recline and leg supports. The chair may be equipped with one or several electrical functions. They are operated with a hand control. A separate user manual for Netti III EL is available.

i Electrical components are mounted by Alu Rehab or certified personnel.

Hand control functions:

1. Recline forward
2. Recline back
3. Tilt back
4. Tilt forward
5. Left foot support up
6. Left foot support down
7. Right foot support up
8. Right foot support down



A holder for hand control can be mounted as accessory.

Weight of components:

Control box:	705 gram
Tilt actuator:	1470 gram
Recline actuator:	1580 gram
Foot support actuator:	920 gram (each)
Hand control:	190 gram
Cable for charger:	20 gram

Total weight all inclusive: 5850 gram

i In the Netti III EL user manual maintenance, charging and handling is described.

5.4 NETTI DYNAMIC SYSTEM KIT

INTENDED USE

Netti Dynamic System is an advanced mobility aid for users affected by dystonia. It is for users with extensive movement patterns resulting in strong spasms and contractions of the user's musculoskeletal apparatus causing joint dislocations, involuntary movements, sliding, loss of function and also challenging the strength of the wheelchair.

Netti Dynamic System kit is ordered and installed by Alu Rehab.

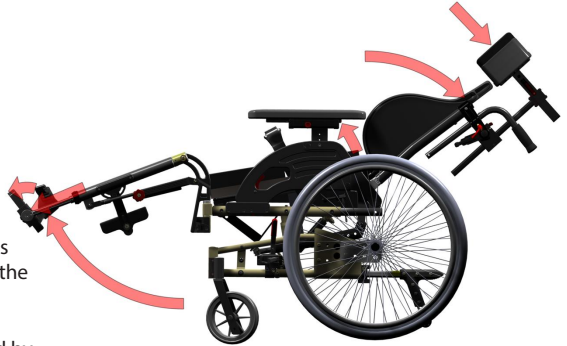

THE KIT CONTAINS:

- Netti Dynamic Leg supports
- Netti Dynamic seat plate
- Netti Dynamic chair back cylinder
- Netti Dynamic head support
- Frame extender
- Pelvic stabilizer - hip-belt
- Shoe shells

The patented Netti Dynamic System accommodates the user's extension movements letting the wheelchair work in synergy with the user's movements. When accommodating the involuntary extensions pattern, muscle tone and frequency of involuntary movements could be reduced. The wheelchair is dynamic and will follow the user's movements of both upper and lower body.

NETTI DYNAMIC SYSTEM

allows for Open Kinetic Chain movements (OK-C):

- Foot movements
- Leg movements
- Hip movements
- Back movements
- Head movements

IMPORTANT BENEFITS

- The wheelchair adapts to the movements of the user.
- The user will have less discomfort during spasm as the wheelchair supports the movement.
- After a spasm the user returns to the original sitting position securing a good position and pressure distribution.
- It prevents unintentional change of position.
- It prevents the user from sliding forward in the chair and thereby getting a bad sitting position and inadequate distribution of pressure.
- Extends the lifetime of the wheelchair.

THE NETTI DYNAMIC SYSTEM CONCEPT:

What is Netti Dynamic Seating?

Netti Dynamic System is a tilt and recline wheelchair which allows controlled Open Kinetic Chain (OK-C) movements of the user. Static comfort wheelchairs can be accommodated to support the user's distal segments. The controlled OK-C movement has an extra impact: The distal segments can move, with a moderate resistance.

OK-C helps to gain control of the proximal segments, especially when the user cannot inhibit muscle movements due to their medical condition.

Netti Dynamic System is a modular system that can be customized and adjusted according to the user's need.

Typically Netti Dynamic System or its components may be used for wheelchair users with involuntary movements.

Before using Netti Dynamic System (NDS) or any of its components, a seating assessment should be carried out by a trained professional.



The therapist's adaptations and settings of the dynamic system must not be changed by unskilled people.

ASSESSMENT OF DYNAMIC BACK SUPPORT GAS CYLINDER FORCES, SUITING USER STRENGTH AND MOVEMENT PATTERNS.

An assessment of the user is needed to find the right power of the cylinder.

Correct solution: The back cylinder gives full support on a full, open kinetic chain movement during the user's extension pattern. When the user starts to relax, the cylinder moves the back support to its original position.

Main factors to be considered by a trained professional:

- The user's weight, width and height
- The character and strength of the body part extensions and movement patterns
- Goals and improvement regarding the user's "Activity daily life" and health condition.

The user's movement pattern and muscle tone may also change over time. It is relevant to assess and monitor the fitting of the wheelchair and the power of gas cylinders according to the development of the user's movement pattern and muscle tone over time. If the gas spring is too strong, the user will not be able to make an extension. It will be a "closed kinetic chain", or a static position for the user.

If the gas spring is too weak, the user will not be lifted back to his/hers original seating position after an extension of the upper body part.

CHAIR BACK HEIGHT

The chair back can be extended by mounting a back extension.

NETTI DYNAMIC HEAD SUPPORT

The Netti Dynamic System is equipped with a dynamic head support. The head support follows the extension movement of the neck.

The depth of the head support should be adjusted to barely touch the back of the user's head when sitting relaxed.

MOUNTING, POSITIONING AND ADJUSTMENTS OF PELVIC SUPPORTS AND SUPPORTIVE HARNESSSES

Netti Dynamic System can be equipped with several different types of pelvic stabilizer and supportive harnesses each type developed to give the user the best stabilization support depending on the conditions:

- Pelvic stabilizer – (included in Netti Dynamic System)
- Upper body harnesses
- Ankle huggers
- Shoe shells
- Pelvic stabilizer, mounted to the seat plate, helps the user to keep his position on the seat even under full spastic extension.

 **Always use pelvic stabilizer / hip belt when upper body harness is used.**

See separate Mounting Description for upper body harnesses.

Detailed descriptions are found in separate user manuals for

- UM0116UK Netti Dynamic System, seat, back and head support.
- UM0115UK Netti Dynamic System Leg supports.

Both are available at our homepage: www.My-Netti.com or at your dealer.

6. ASSEMBLING AND ADJUSTING

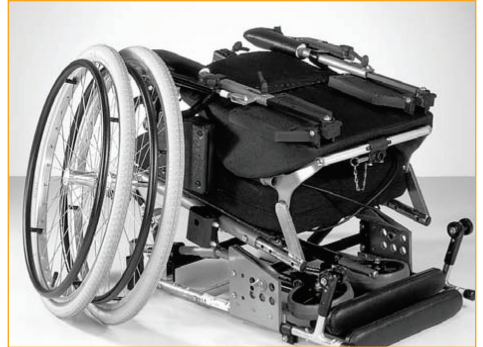

6.1 UNPACKING (SEE CHAPTER 5 & 6)

1. Unpack all the parts, and check that everything is there according to the packing list.
2. Mount main wheels and front castors.
3. Mount back rest, arm supports, cushions and leg supports.
4. Mount accessories.

Weight of components (450 mm chair width):

Drive wheels:	1,90 kg each
Front castors:	0,80 kg each
Leg support angle adj.:	2,10 kg each
Uno Back:	1,25 kg
Netti Sit:	1,00 kg
Head support A:	1,00 kg
Head support C:	0,90 kg
Arm support:	1,10 kg

Necessary tools are described under each chapter. Accessories described in chapter 5 is a presentation of options, and will be delivered with separate mounting descriptions.

When seating and wheel adjustments are done in the possible positions by standard equipment, the adjustments will not exceed safe limits.

6.2 DRIVE WHEELS

To mount the drive wheel remove the quick release bolt from the hub bushing, lead it through the centre of the main wheel and into the hub bushing while pressing the knob in centre.



i To check that the drive wheel is properly attached to the hub, remove the finger from the central knob and pull the main wheel.

⚠ If the drive wheel does not lock, see troubleshooting and adjust. If it still does not lock, do not use the wheelchair but contact your dealer.

i Sand and sea water (salt used for gritting in the winter) can damage the bearings of the main wheels. Clean the wheelchair thoroughly after exposure.

6.3 FRONT FORK

Front forks come as standard with quick release axles. The front fork is easily removed by pressing the quick release button on top of the bearing house. Press it through the silicon button sitting on top.

👍 Check angle of castor bearing house (See chapter 6.5).



6.4 FRONT CASTORS

To take off

- Press the release button on top of the front fork bearing house - underneath the silicon cap.



To mount

- Lead the quick release axle into the bearing house. Pull the fork slightly to ensure that the fork is fully locked.



i Sand and sea water (salt used for gritting in the winter) can damage the bearings of the front castors. Clean the wheelchair thoroughly after exposure.

6.5 SEAT HEIGHT AT THE FRONT

The seat height depends on:

- Size of front castors.
- Size of front fork.
- Check the angle of the castor bearing house.



In chapter 5 the overview shows that you can choose between several models of both front castors and front forks.

To change the height of the front castors – unfix the wheel and replace it in the required position in the front fork.

Angle of bearing house

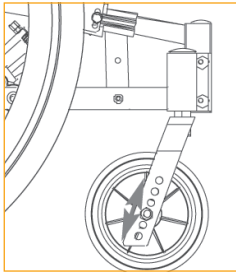
Correctly adjusted angle of the front fork is important to achieve proper manoeuvring qualities of the wheelchair. Unfix the two screws on the inside of the frame enough to adjust the eccentric nuts. Angle the bearing house, so that it is 90° relative to the ground. Tighten the screws with 16 Nm.



-  1 pc 5 mm Allen key.
-  The bearing house can not be adjusted in height.
-  Check and adjust the position of the anti tip if necessary.







6.6 SEAT HEIGHT AT THE REAR

The seat height at the rear depends on:

- Size of main wheel.
- Position of main wheel.

Main wheel

Loosen the hub bushing, including washer and nut, and mount it in required position in the main wheel bracket.

-  2 pcs 24 mm open-end spanner.
-  Make sure that the nut on inside of frame totally wreathes the wheel bushing.
-  When the seat height is changed make sure that the bearing house of the front castors are adjusted vertical to the ground.
-  The risk for tipping increases when the main wheel is moved forward in the main wheel bracket.
-  Check the position of anti tip.
-  Readjust the brakes (See chapter 6.17).
-  Readjust the angle of the bearing house (See chapter 6.5).

6.7 BACK REST

- Unfold and lift the back rest up and fit the gas strut into the bracket.
- Secure the back rest by pushing the locking bolt in from the side, through the bracket and gas strut head.



6.8 ADJUSTING THE SEAT DEPTH

The seat depth can be adjusted both in the back and in the front of the seat. Adjustments are done to give the user a comfortable seating position with proper lumbar support while the knee joint is aligned with the leg support knee joint.

By adjusting the seat depth the chair balance and the driving characteristics may change. **A well balanced chair is easy to drive without easily tipping backwards.** Always start with adjusting the seat depth backwards, then adjust the leg support fixing bracket to make the leg support knee joint align with the user knee joint. If necessary the driving wheel position also needs to be change.

The seat depth can be adjusted 100 mm in the rear and 100 mm in front.

ADJUSTING SEAT DEPTH AT THE REAR

Adjusting seat depth at the rear:

- The back rest hinge has 5 holes with 25 mm distance between them.
- The seat depth can be adjusted from 400–500 mm (Measured from front of seat plate to backrest tube without backrest cushion).
- On the frame under the chair plate there is mounted an extra locking head for the gas strut.
- The short locking head covers seat depth 400 mm, 425 mm and 450 mm.
- The long locking head covers seat depth 450 mm, 475 mm and 500 mm. (There is also a long back rest hinge which covers longer seat depths. See chapter 5).



- When changing the position of the back rest hinge, also remember to change the position of the gas strut under the chair. The bracket has 3 holes. When the back rest hinge is set in the shortest position, the gas spring is placed in the front hole using the short locking head.

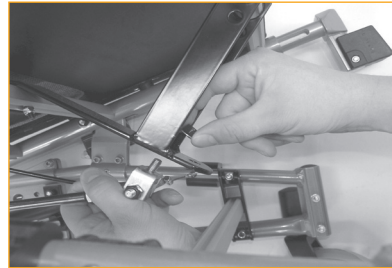

For each position the back rest hinge is pulled out, the gas spring is moved one hole towards the rear. When the gas spring reaches the rearmost hole with short locking head, change to long locking head and start from the front hole again.



When using the comfort seat plate it is recommended to change seat plate when changing seat depth. The seat plate comes in depth: 400 mm, 430 mm & 460 mm.



By using the Velcro adjustment straps in the chair-back you can gain a few cm on the depth.

6.9 ADJUSTING SEAT DEPTH AT THE FRONT

Seat depth in the rear is adjusted as follows:

- Release the tilt gas strut by tilting the seat all the way forward.
- Pull out the locking bolt for the backrest, and place the back rest forward in the seat.
- Remove the screws holding the back rest hinge, and set the hinge to a position which gives the backrest the required position. Do both sides at the same time.
- Place the screws back and fix them.
- Also remember to move the gas strut as described earlier in this chapter – to reach 90° back angle when the gas strut bottoms.

 When adjusting the seat depth at the rear, the screw in the backrest hinge must be tightened with 14 Nm.

 6 mm Allen key.
13 mm open-end spanner.

 If the user requires another back rest angle than what is standard, it is possible to change the position of the gas strut in three positions under the chair in front.

 When changing seat depth, you also change the tipping point of the chair. This can be prevented by changing the position of the main wheel in the main wheel bracket (See chapter 6.6). Adjust anti-tippers accordingly (See chapter 6.10).

It is possible to adjust the seat depth up to 90 mm at the front. For easy seat depth adjustment seat depth extension brackets can be delivered (+45 mm). They sit on the wheel frame. By restless users the extension piece should not be pulled out more than 50 mm.

Do the following:

- Loosen the screw holding the extension piece for the leg support.

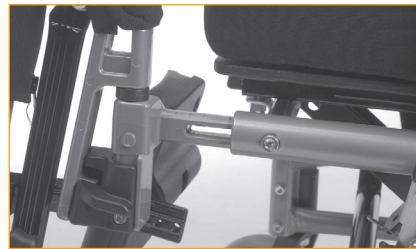

- Set the extension piece to the required position.
- Place the seat plate extender on the leg support extension pieces.
- Fix the screws, tighten them with 25 Nm.

 6 mm Allen key.

 By setting the leg support extension pieces to different positions – different position / depth of the leg supports, it is possible to compensate for a rotated pelvis or different length of thighs.

 Never use the sliding seat plate in forward position as seat depth extension.

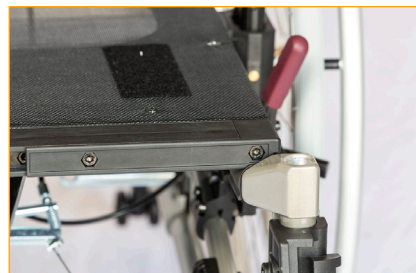

6.10 ANTI-TIP

- Adjust the anti-tip so that it does not stick outside the radius of the wheel.
- Pull the anti-tip out / rearwards from the chassis.
- Turn it down 180°.
- Lock it in position by moving forwards with the spring tension.



- i** The anti-tips are delivered adjusted according to ordered main wheel size in standard position. If other adjustments are carried out, anti-tips have to be adjusted accordingly.

Adjusting anti-tip

The anti-tips must be adjusted whenever the position or dimension of the main wheels are changed.

Correctly adjusted anti-tips should be positioned just on the inside of the radius of the main wheel.

Anti-tips are adjusted as follows:

- Unfix the locking clamp on the anti-tip bar using an Allen key.
- Pull or push the bar to required position.
- Fix the locking clamp.
- Do the same procedure on the opposite side.

- wrench** 6 mm Allen key.

- i** Check that both anti-tips have the same length. The gap between the anti tip wheels and the floor must be 20 - 30 mm.

- i** If the anti-tip is positioned on the outside of the main wheel radius, it will interfere with curbs and stairs.

- i** The anti-tip should always be used for the safety of the user.

6.11 ADJUSTING ARM SUPPORTS

- Turn the arm support release handle to the side and hold.
- Adjust the armrest to the required height and release the handle. Lift or lower the armrest slightly until it locks.



- thumbs up** The arm pad and locking screw are set in the middle position. This can be adjusted to fit the user.

6.12 CUSHIONS

Cushions are fixed and adjusted on the wheelchair using the Velcro.



It is imperative to correctly set-up the cushion in order to ensure good seating comfort.



The cushion covers are washable and thereby reusable. Follow the instruction on the back of the cushion for correct maintenance and washing of the cushion.

6.13 ADJUSTING THE VELCRO BACK

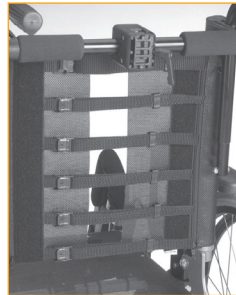

- Loosen the straps, and place the back rest cushion so that user gets room for the bottom and the integrated lumbar support in correct position.
- Tighten the straps so that they follow the curvature of the spine and gives a little extra support at the top of the sacrum.

6.14 LEG SUPPORTS

Netti III has following alternative leg supports:

- Universal leg support.
- Angle adjustable leg support standard.
- Grandis.
- Amputation leg support.

See chapter 5 for pictures.

As standard Netti III is delivered with Angel adjustable leg support. Netti III HD is delivered with Angle adjustable leg support HD.

The angle adjustable leg supports are swingable, height adjustable and removable. They come with height- and depth adjustable calf supports. The foot plates are hinged, and can be angled in fixed positions.

The foot plates come with a lock connecting the 2 plates which makes the plates stronger. If locking is not wanted, the bolt can be removed by using an Allen key with no loss of functionality.

MOUNTING OF ANGLE ADJUSTABLE LEG SUPPORT STANDARD:

Leg support mounting instruction:

- Fold the foot plates up.
- Hold the leg support on the top joint, and place it in the pull-out-piece in an outward turned angle as shown in the picture below.
- Swing the leg support inwards and push slightly downwards until it goes into locked position.

Angle adjustment

Loosen the star wheel on the outside of the leg support. Lift the lower part of the leg support to required angle. Tighten the star wheel.



i Be aware of squeeze hazard between moving parts.



Foot plate height adjustment:

The foot plates are step less height adjustable.

- Unfix the adjustment screw so that the adjustment bar moves freely.
- Slide the foot plate to required height, tighten the screw.

i As an accessory a star knob can replace the screw.



Foot plate angle adjustment:

- Loosen the screw on the outside of the foot plate - see picture above - with an Allen key.
- Tilt the foot plate to required angle and tighten the screw.





5 mm Alan key.

Foot plate lock

Locking and releasing the foot plates

- The foot plates can be delivered with a lock connecting the 2 footplates which makes the plates stronger.
- To lock the foot plates, let the right foot plate fall over the bolt standing out from the left one, it clicks into lock.
- To release the foot plate pull the plastic lock between the foot plates and lift the right foot plate up.



-  While making the adjustment, there must be no load on the foot plates.
-  For outdoor use, there should be a clearance of 40–50 mm between the foot plate and the ground.
-  Never stand on the foot plates due to the risk of tipping forward.

Removing the leg support:

If there is a foot plate lock, release the foot plate by pulling the red plastic lock between the foot plates.

- Lift the right foot plate up.
- Lift the leg support in the knee joint slightly up.
- Swing it outwards – see picture below.
- Lift it up.



-  When adjusting leg support angle, be aware of squeeze hazard between moving parts.

Calf support adjustments

The calf supports are height and depth adjustable. The calf supports are to be adjusted in a height and depth that prevents the feet from sliding down from the foot plate.



To adjust the height, loosen the nut **A** on the calf support bracket and slide it into required position before fixing the screw.

-  10 mm open end spanner.

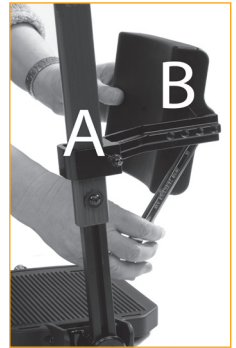
To adjust in depth of the calf pad, loosen the screw **B** between the calf support and bracket and reposition it to required position before fixing the screw again.



-  13 mm Allen key.

-  Never stand on the foot plates!
-  Never lift the wheelchair by the leg supports.

MOUNTING OF ANGLE ADJUSTABLE LEG SUPPORT GRANDIS:

The angle adjustable leg support Grandis is the standard leg support for Netti III HD.



It is swingable and removable. It is height adjustable and comes with height- and depth adjustable calf support. The foot plates are hinged, and can be angled in fixed positions. As a standard the foot plates come with a lock connecting the 2 plates which makes the plates stronger and reduces maintenance. If locking is not wanted, the bolt can be removed by using an Allen key.

Mounting of the leg support:

- Fold the foot plates up.
- Hold the leg support on the top joint, and place it in the pull-out-piece in an angle as shown in the picture below.
- Swing the leg support inwards and push slightly downwards until it goes into locked position.

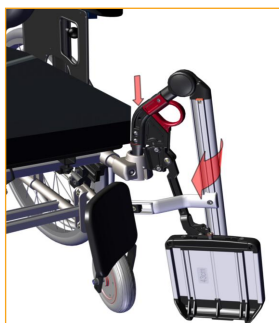

To adjust the angle of the leg support simply release the red lever and lift or lower. The leg support will stay in the position where you lock the lever.



Foot plate height adjustment:

The foot plates are step less height adjustable.

- Unfix the adjustment screw so that the adjustment bar moves freely.
- Slide the foot plate to required height, then tighten the screw.

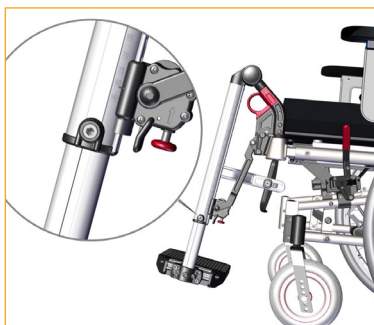

Foot plate angle adjustment:

- Unfix the 2 screws as shown below using a 5 mm Allen key.
- Adjust the foot plate to the required angle and tighten the screws.



Foot plate depth adjustment:

- Unfix the 2 screws completely as shown below, using an 5 mm Allen key.
- Pull out the foot plate and loosen the next 2 screws which has become visible.
- Slide the footplate forwards or backwards to desired depth before refixing all screws.

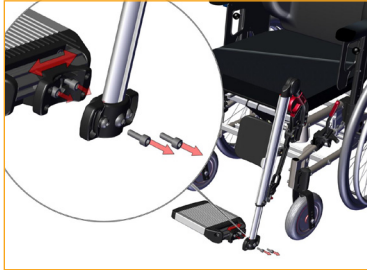

Locking and releasing the foot plates:

- The foot plates come with a lock connecting the 2 foot plates which makes the plates stronger.
- To lock the foot plates let the right foot plate fall over the bolt standing out from the left one, it clicks into lock.
- To release the foot plate push the plastic knob under the right foot plate and lift the right foot plate up.



i While making the adjustment, there must be no load on the foot plates.

i For outdoor use, there should be a clearance of 40-50 mm between the foot plate and the ground.

⚠ Never stand on the foot plates due to the risk of tipping forward.

i When adjusting leg support angle, be aware of squeeze hazard between moving parts.

Removing the leg support:

- Release the foot plate by pushing the red plastic knob under the right foot plate and lift the right foot plate up.
- Pull the red circular grip on top of the leg support and lift the support upwards while turning it slightly outwards. see illustration on next page.



Calf support adjustments

The calf support is height and depth adjustable. The calf supports are to be adjusted in a height and depth that prevents the feet from sliding down from the foot plate.

To adjust the height, loosen the screw on the calf support bracket and slide it into required position before fixing the screw.



5 mm Allen key.



To adjust in depth of the calf pad, loosen the screw holding the calf support and slide it to required position before fixing the screw again.



5 mm Allen key.



Never stand on the foot plates!



Never lift the wheelchair by the leg supports.

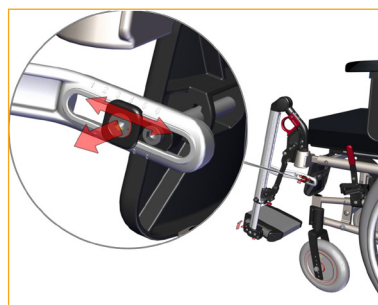

6.15 HEAD SUPPORT

- A - Lever for depth adjustment
- B - Wheel for angle adjustment
- C - Lever for height adjustment
- D - Head support bracket.

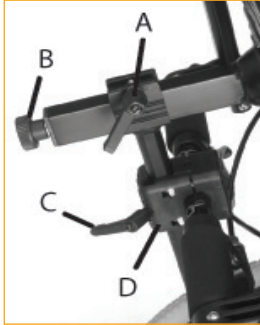

- Place the squared nut in the trace of the head support bracket as shown below.



- Place the head support in the head support bracket.
- The height and the depth of the head support is set to the required positions and tightened.
- The head support bracket is fixed by tightening the four screws two by two diagonally so the bracket is fixed with the same strength divided on the four screws.

Adjusting the head support in depth:

- Release the locking lever on top of the vertical bar (A).
- Adjust the head support and fix it in required position.

Adjusting the head support in height:

- Release the locking lever on the head support adapter (C).
- Adjust the head support and fix it in required position.

Adjusting the head support in angle:

- Release the adjustment wheel at the rear of the horizontal bar (B).
- Adjust the head support and fix it in required position.

Adjusting the head support sideways:

- The head support adapter can be moved both to the right and left, giving the possibility to accommodate special needs for head support.
- Loosen the four screws holding the adapter together.
- Move the adapter to the required position and fix the adapter by tightening the screws diagonally.



Remember to release the levers when adjusting the head support.



If the head support stand does not fit the bracket perfectly, the bracket is probably fixed too tight or unevenly. After fitting the head support, fix it properly by tightening the little set screw in the centre on top of the head support bracket using an Allen-key.



If the head support seems too short in height, it can be turned 180° by releasing the adjustment wheel at the rear of the horizontal bar (B).

6.16 PUSH HANDLES

Adjustment of push handles:

- Release the lever on the side and lift the handle all the way up.
- Turn the handles into required position.
- Adjust height.
- Lock the handle in required position by tightening the lever.



Check that the safety screw is properly tightened.



To remove the handles, the safety screw at the bottom of the handles also has to be removed.

6.17 ADJUSTING THE BRAKES

- The brakes are freely adjustable along the frame tube.
- To activate the brake, push the handle forward.



- To release the brake, pull the handle rearwards.



- To reposition the brake, loosen the two screws on the inside of the brake clamp.



- For fine adjustment, loosen the upper screw on the inside of the brakes.
- Adjust the brake position and tighten the screws.



5 mm Allen key.

- i** Check that the brakes are correctly adjusted by activating the brakes and be sure that the wheelchair doesn't move.
- i** The brake bolt engaging with the tyre when the brake is locked, must engage with the complete width of the tyre.
- i** The braking bolt hitting the tyre shall have a distance of 15 mm to the tyre when the brake is open. To be measured with a R15mm tube pushed over the braking bolt. The tube shall touch the tyre when the brake is open. This ensures an operating force of the brake of ca 60N.
- i** The brakes are constructed as parking brakes and shall not be used as driving brakes.
- i** Be aware of potential squeeze hazard between brake and tyre.

DRUM BRAKE

If the wheelchair is fitted with hand operated hub brakes, they operate drum brakes.





If the brake doesn't brake properly:

To adjust the wire on one or both sides, adjust the foot screw 2-4 rounds out. Then re-check the brakes.

If the wire is too loose:

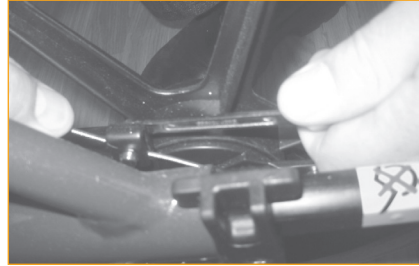
Adjust the foot screw all the way in. Tighten the wire by loosening the wire clamp before pulling the wire further through it. Tighten the wire clamp, and adjust the foot screw out again.



-  1 pc 10 mm open-end spanner.

-  To ensure the correct functions of the wire, these must never be taut.

Operating and applying the brake

The wheelbase in drum brake is fitted with hand operated hub brakes to allow regulation of speed on hills and whilst traveling along. These are located on the push handles.

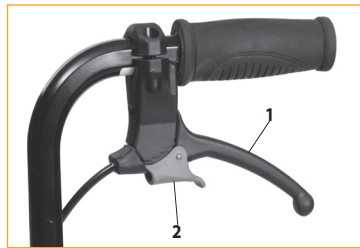

- To apply the brakes, pull the brake levers (1) evenly and smoothly towards handle and bring the wheelbase to a stop.
- For activating and locking the parking brake (2) press the lever (1) against the push handle and lock the parking brake with the finger. Be sure that both parking brakes are locked.
- The parking brake will be released when you press the lever (1) against the push handle. It is locked with a spring and this will release it.

-  Do not leave the user in the wheelchair without activating the parking brake.

7. SEAT ANGLE / TILT AND BACK ANGLE / RECLINE

7.1 SEAT ANGLE

The seat angle is regulated using the release handle mounted on the push bar.

The seat unit can be tilted from -9° to $+16^{\circ}$.



7.2 BACKREST ANGLE

The backrest angle is regulated using the release handle mounted on the push bar. The angle can be regulated from 4° forward to 40° backwards.

i To ensure correct function of the wires, these must never be taut.

i The seat and back-rest angle must not be adjusted without using the anti-tips.

The release handles has each on of the following label:



Tilt



Recline

i Risk for tipping.
Check the position of anti-tip.

i When chair back extension is mounted, the tipping risk increases. If necessary it should be improved by moving the main wheels further back. Always use anti tippers when recline and tilt functions are seeing activated.

7.3 KEY WORDS REGARDING TILT AND RECLINE OF STATIC COMFORT WHEELCHAIRS, AND COMMON FEATURES OF DYNAMIC WHEELCHAIRS

Tilt and recline are the basic benefits of a comfort wheelchair. It allows for varying seating positions during the time in the wheelchair.

We have reviewed the clinical evidences regarding tilt and recline, and found there are several studies or best practice guidelines suggesting that the tilt and recline sequence is important to reduce shear and sliding:

First tilt then recline afterwards. When bringing the client upright again, the sequence should be recline first then tilt. It would seem that the most shear would be induced when going upright from a recline and tilted position.

7.4 DECREASE THE POSSIBILITY OF SLIDING, SHEAR AND PRESSURE SORES:

Only use the tilt angle to achieve variation of the seating position for the user. It is common knowledge that recline should not be adjusted after the back angle is accommodated to the user's best seating position.

The muscle tone of the neck and back should be as low as possible for the user to prevent sliding, and a change of the recline angle from the original position will interrupt and destroy the correct body position, and cause an increased muscle tone in the neck.

If the recline function is used during a transfer situation or other situations, it is very important that the recline angle is adjusted back to the correct, original position when the user is back to a normal seating position.

Wrong usage of recline causes an increased possibility of sliding, and this means an increased danger of shear (vertical and horizontal forces) and pressure sores.

MAKE SURE THAT THE USER IS SAFE WHEN THE TILT OR RECLINE FEATURES ARE GOING TO BE ADJUSTED:

The tilt and recline functions of all Netti comfort wheelchair models is a «one hand operation», including the dynamic wheelchair models. This is a great benefit for the user: The care giver is able to establish eye contact with the user when the tilt or recline function is going to be used. The care giver is also able to communicate with the user before the tilt or recline function is used. The user will feel more safe when he/she is aware that the tilt or recline function is going to be used.

7.5 OPERATING TILT HANDLE: TILTING THE SEATING UNIT

Press the left handle on the push bar and put pressure to the push bar to tilt the seating unit with one of your hands, while you have eye contact with the user and put the other hand on the arm support.

The correct relative angle between the body parts remain the same when the seating unit is tilted.

Wherever you let the handle loose, the seating unit will stay in this position. To bring the seating unit up, press the handle and the tilt cylinder will assist you lifting the seating unit up.

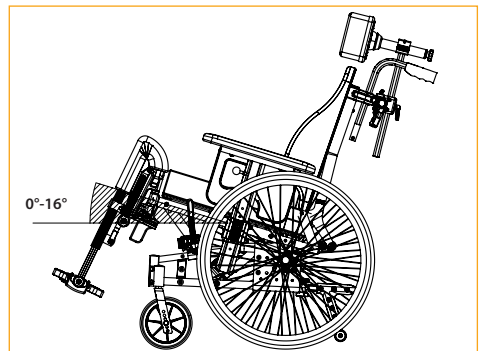

A backward tilted seat unit gives a steeper seating angle in relation to the surface, and prevent sliding of the wheelchair user.

A forward tilted seat unit brings the user in a position where activities - for instance by a table or by standing up from the wheelchair, is supported.

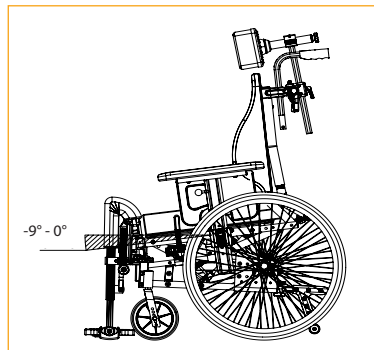

The tilt handle and the tilt sign is on the push bar – shown on the previous page.

 **Never leave the user alone when the seat is tilted forwards. The user can slide forward.**

7.6 OPERATING RECLINE HANDLE: RECLINING THE CHAIR BACK

Press the right handle and put pressure to the push bar to recline the back with one of your hands, while you have eye contact with the user and put the other hand on the arm support. Wherever you let the handle loose, the chair back will stay fixed and locked.

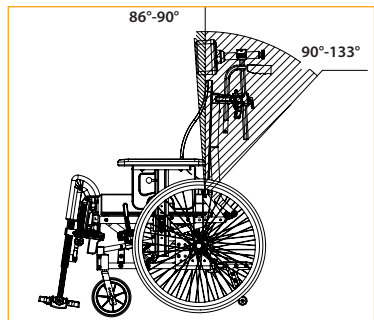



8. TRANSPORT

 **Whenever possible transfer to a car seat with vehicle safety belts when you are travelling with a car. Secure the wheelchair or store it in the cargo area of the car.**

Netti III and Netti III HD are crash tested and approved according to ISO 7176-19:2008 stating it is suitable to be used as a seat in a vehicle.

In the following chapter the descriptions are valid for both Netti III and Netti III HD and will only be named with Netti III.

 **Netti III with seat width up to 500 mm is approved for max user weight of 135 kg when used as a seat in a vehicle.**

 **Netti III HD with seat width 350-600 mm is approved for user weight up to 160 kg when used as a seat in a vehicle.**

8.1 TRANSPORT IN CAR



Before using the Netti III as a seat in a car, be sure to remove and secure all parts (e.g. trays) and accessories that may fall off in case of an accident in a suitable location, cargo area. Please note: in the following text the naming “Netti III” also covers Netti III HD.

 **Always use approved wheelchair and occupant restraint system (ISO 10452:2012) , for fixing the wheelchair in the vehicle. Netti III has been successfully crash tested – forward facing – using a combined wheelchair and occupant restraint system W120/DISR developed by UnwinSafety Systems. For further information: www.Wheelchairsecurementsystemsforvehicles.com | BraunAbility Europe**

 **The corrective harnesses used in the wheelchair are not safety belts.**

 Please be aware that wider wheelchairs have bigger turning radius and reduced manoeuvrability in vehicles. Smaller wheelchairs generally provide greater ease of vehicle access and manoeuvrability to a forward facing position.

WHEELCHAIR SECURING

In front: Use hook or strap attachment.



Stickers show where to fix the straps in the front.

In rear: Mount car fixing bracket in 2 holes in the wheel bracket - one on each side.

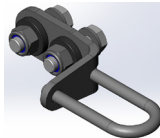

Hook on a hook / carabiner in the car fixing bracket

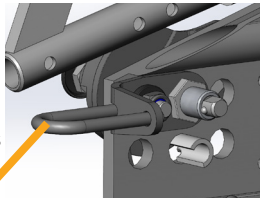

The angle of the straps should be close to 45°.

⚠ Never fix the chair in other parts than the designated car fixing brackets.

SECURING THE USER

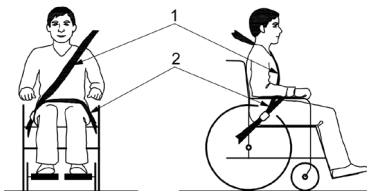

Always use the occupant restraint belts in the car with both pelvic and shoulder belts for the wheelchair user. Use both pelvic and shoulder restraints to reduce the possibility of head and chest impact with vehicle components.

i The corrective harnesses used in a wheelchair are not safety belts.

The rating of the wheelchair's accommodation of vehicle-anchored belt restrains is A = good.

i Make sure that:

- the 3 point safety belts sits close to the user body (not across the arm supports, wheels),

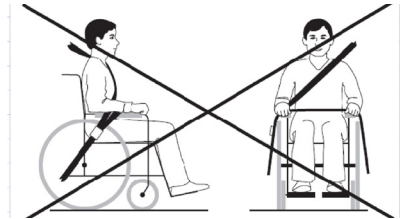

- the webbing is not twisted,
- the seat belt buckle and its release button is positioned so that it will not be in contacted by wheelchair components during crash.
- the pelvic safety belt lays tight across the pelvis or the upper thighs with an angle to the seat of 30 - 70 grader, the steeper the better.

i Always use Netti Cushions or other approved foam cushions when Netti III wheelchair is used as a seat in a car.

i When the user is 1.85 m or longer and using Netti III as a seat in a car, the back rest extension must be mounted.

i If a Netti head support is mounted correctly it is very stable but does not replace the need for external neck support mounted in the car.

i Netti III has been crash tested without any power kit etc. If, at a later point of time a power kit, stair climber etc. is mounted, you need to check if your power assistant device is crash tested and approved for wheelchairs being used as seat in a car. If not, this must be dismantled when the wheelchair is used as a seat in a car.

 Never use the wheelchair as seat in cars if it has been involved in an accident with impact **before it has been inspected and approved for this by the manufacturer's representative.**

 Never do alterations or substitutions to wheelchair securement points or structural and frame parts or components without consulting the manufacturer.

 For more details see UM0131: How to use a wheelchair as a seat in a car.

8.2 TRANSPORT IN AIR-PLANE

Netti III and Netti III HD wheelchair may be transported in air-plane without any restrictions. Netti III wheelchairs are equipped with 2 or 3 (HD) gas springs. These are however not classified as dangerous goods. Contrary to general dangerous goods instruction UN3164, the IATA-DGR (special regulation A114) rules that the goods that contain gas and are determined to function as shock absorbers (including energy-absorbing devices or pneumatic springs) are NOT subject to the transport instructions i.e. they are indemnified from the following requirements:

- a) Each article has a gas volume which does not exceed 1,6 l and a charge pressure not exceeding 250 bar, where the product of the capacity expressed in liters and charge pressure expressed in bars doesn't not exceed 80.
- b) Each article has a minimum burst pressure of 4 times the charge pressure at +20 degree Celsius for products not exceeding 0,5 l gas space capacity.
- c) Each article is made of material that will not fragment.
- d) Each article was manufactured in accordance to quality standard which is approved by the responsible national authority.
- e) It is proven and shown that the article relieves its pressure by means of a fire degradable seal or other pressure relief device such that the article will not fragment and the article does not rocket.

8.3 TRAVELLING BY PUBLIC TRANSPORT

The wheelchair should be put in a special area for wheelchairs. The wheelchair should face opposite the direction of travel. The back of the wheelchair must be located against a fixed object such as a row of seats or a partition. Make sure the user can easily reach any hand rails or handles. Use belts and harnesses in the chair to hold the user. Use safety belts if available to secure the user in the vehicle.

 Netti III with seat width 500 mm and more, exceed the max width of 700 mm specified in PRM-TSI and have influence on the possibility for train transport and other public transport.

 EMERGENCY ESCAPE ROUTES: Netti III with seat width 500 mm and more, has an overall width exceeding 700 mm and may have difficulties passing emergency escape routes.

 Please be aware that wider wheelchairs have wider turning radius and reduced manoeuvrability in vehicles. Smaller wheelchairs generally provide greater ease of vehicle access and manoeuvrability to a forward facing position.

8.4 FOLDING FOR TRANSPORT

When the wheelchair is unoccupied, fold it as described below. Put the wheelchair in the trunk or the back seat. When placed in the back seat, secure the frame using safety belts.

- Remove head support (chapt. 6.15).
- Turn anti tips up (chapt. 6.10).
- Swing push handles in (chapt. 6.16).
- Remove arm supports (chapt. 6.11).
- Remove leg supports (chapt. 6.14).
- Remove backrest cushion (chapt. 6.12)
- Release backrest and fold it (chapt. 6.7)
- Remove main wheel (chapt. 6.2).
- Remove front castors (chapt. 6.4).

9. MANOEUVRING

9.2 DRIVING TECHNIQUES – STEP UP –

9.1 GENERAL TECHNIQUES

The weight and balance of the chair influences the manoeuvring ability of the wheelchair. The weight, size and sitting position of the user are also influencing factors. Also the position of the wheels will influence the driving performance. The more weight placed over the main wheels, the easier it is to manoeuvre. If heavy weight is placed over the front castors, the chair will be heavy to manoeuvre.

i **Step approach:**
Always approach the step in slow motion preventing the front castors to hit the step with force. The user could fall out of the chair by the impact. The front castors could brake.

i **Driving forward down steps/ sidewalks:**
Be cautious that you do not drive down steps higher than 30 mm. The leg supports may hit the ground first. Thereby you might lose the control and the leg supports may brake.

i **Companion:**
If the user is left alone in the wheelchair, always lock the brakes and secure that the anti-tips are turned down.

i **Parking:**
Increase the underneath support of the wheelchair by moving the chair about 100 mm backwards making the front castors turn forward.

i **Driving on soft, rough or slippery ground:**
Can make safe manoeuvring more difficult as the wheels may lose traction and it is difficult to control the wheelchair.



Companions, drive up a step forwards:

- Check that the anti tip is turned up
- Angle the wheelchair backwards.
- Lift the push handles while pushing the chair onto the step.

i **Turn the anti tip down.**

Users, drive up a step backwards:

This technique is only useful if the step is very low. It also depends on the clearance between the foot plates and the ground.

- Check that the anti tip is turned up.
- Drive the chair backwards towards the step.
- Make a firm grip on the push rims and move the body forward while pulling.

i **Turn the anti tip down.**

Companions, drive up a step backwards:

- Check that the anti tip is turned up
- Pull the chair backwards next to the step
- Angle the wheelchair backwards, moving the front castors slightly up in the air.
- Pull the wheelchair up the step and go backwards long enough to put down the front castors on the step.

i **Turn the anti tip down.**

9.3 DRIVING TECHNIQUES – STEP DOWN –

Companions, drive down a step forwards:

- Check that the anti tip is turned up
- Angle the wheelchair backwards, moving the front castors slightly up in the air.
- Drive carefully down the step and angle the wheelchair forward putting the front castors back on the ground.

 Turn the anti tip down.

Users, drive down a step backwards:

This technique is only for very experienced users. This technique should not be used if the height of the step is more than 100 mm.

- Check that the anti tip is turned up.
- Move the wheelchair backwards to the step.
- Move carefully down the step backwards while moving the body forward to keep the balance of the chair.

 Doing this increases the risk of tipping backwards.

 Turn the anti tip down.

Companions, drive down a step backwards:

- Check that the anti tip is turned up.
- Move the wheelchair backwards to the step.
- Drive carefully down the step and move the wheelchair backwards on the main wheel until the front castors have come away from the step.
- Put the front castors down on the ground.

 Turn the anti tip down.

9.4 DRIVING TECHNIQUES – SLOPE –

Important advise for driving down and up hill avoiding the risk of tipping.

 Avoid turning the wheelchair in the middle of a slope.

 Always drive as straight as possible.

 It is better to ask for assistance than taking risks.

Driving uphill:

Move the upper part of the body forwards in order to maintain the balance of the chair.

Driving downhill:

Move the upper part of the body backwards to maintain balance of the chair. Control the speed of the chair by clutching the push rims. Do not use the brakes.



9.5 DRIVING TECHNIQUES – UP STAIRS –

 Always ask for assistance.

 Never use escalators, even if assisted by a companion.

With assistance, backwards:

- Check that the anti tip is turned up, and that the push handles are fixed properly.
- Pull the wheelchair backwards to the first step of the stairs.
- Angle the wheelchair backwards on the main wheels.
- Pull the wheelchair slowly up the stair, one step at the time keeping the balance on the main wheel.
- Reaching the top of the stair, pull the wheelchair backwards far enough to put the front castors safely down on the floor.

 If two companions are present, one person can assist lifting in the front of the frame. Lifting points on the frame are marked with this sign:



 The companions should use the strength in their legs carrying the chair, avoiding unnecessary stress on the back.

 Do not lift the wheelchair holding onto the leg, arm or head supports.

 Turn the anti tip down.

9.6 DRIVING TECHNIQUES – DOWN STAIRS –

 Never use escalators, even if assisted by a companion.

With assistance, forwards:

- Check that the anti tip is turned up and that the push handles are fixed properly.
- Drive the wheelchair forward to the first step of the stair.
- Angle the wheelchair backwards on the main wheels.
- Have a firm grip on the push handles, and keep the balance on the main wheel taking one step at the time.
- Reaching the bottom of the stair, put the front castors safely down on the floor.

 If two companions are present, one person can assist lifting in the front of the frame. Lifting points on the frame are marked with this sign:



 Do not lift the wheelchair holding onto the leg, arm or head supports.

 Turn the anti tip down.

9.7 TRANSFER

Techniques for transferring to/from the wheelchair should be practiced well with the persons involved. Here, we give some important advices for preparation of the chair:



USING A LIFT:

Before transfer to chair:

- Tilt the chair back.
- Remove the head support.
- Remove the leg supports.
- Open the back rest angle slightly.
- Replace the components when transfer is finished.



With or without companion – sideways.

Before transfer:

- The wheelchair should be placed as close as possible to the destination of the transfer.
- Pull the wheelchair backwards 50–100mm in order to make the front castors turn forward.
- Lock the brakes.
- Remove leg support and arm support on the side of the transfer.

With or without companion – forwards.

Before transfer:

- The wheelchair should be placed as close as possible to the destination of the transfer.
- Pull the wheelchair backwards 50–100 mm in order to make the front castors turn forward.
- Lock the brakes and tilt the chair forward.



Never stand on the foot plates due to the risk of tipping the chair forwards.

9.8 POINT OF BALANCE

A well balanced wheelchair is easy to drive without the tendency to tip backwards. Too much load on the front castors makes it heavy to drive. If necessary adjust the point of balance by changing the position of the main wheel in the main wheel bracket.

- Move the main wheel hub and the main wheel (see chapter 6.6).
- Adjust the brakes. (see chapter 6.17).



2 pcs 24 mm open-end spanner.



5 mm Allen key.

When the main wheels are moved forward, it will be easier to manoeuvre the wheelchair, but the risk of tipping backwards increases.



The point of balance can also be changed by adjusting the seat depth, the seat angle and / or angle of the backrest.



Always use the anti tippers.



Check that the main wheel and quick release are locked properly (see chapter 6.2).

9.9 LIFTING THE WHEELCHAIR

- The unfolded wheelchair should be lifted from 2 persons holding on to the frame and push bar only. The chair is marked with the symbol where it should be lifted.



Never lift the wheelchair in the leg, arm or head supports. They may detach and the wheelchair may fall and get damaged.



Never lift the wheelchair with a user in it.

9.10 PUSH RIM

Netti wheelchairs are delivered with aluminium push rims as standard. The material and distance to the main wheel influences the ability of the user to grip. Contact your dealer to get information about push rims that fit your chair.



Alternative push rims may give better grip, but the friction may increase. When using the hands to stop the chair, the risk for burning of the hands increases.



A squeezing and trapping hazard of the fingers may occur when passing through narrow passages and if the fingers come between the spokes. To avoid this risk, we recommend spoke protectors as accessory.



If you want / need to change push rims or increase / decrease the distance between the push rims and the wheel, please contact your dealer.

10. MAINTENANCE

10.1 MAINTENANCE INSTRUCTIONS

i You as a user of the wheelchair (and your attendants and family) are responsible for the everyday maintenance of the chair. Clean it regularly. Do the maintenance to assure safe and long time reliable functions and hygienic appearance.

Frequency	Weekly	Monthly
Check defects / damages e.g. breakage / missing parts	X	
Washing of wheelchair		X
Washing of cushions		X
Check anti tip function		X
Check brake adjustment		X
Check tyre wear		X
Oiling of bearings with bicycle oil		x
Grease vertical leg support profiles with white vaseline	X	

10.2 CLEANING AND WASHING

1. Remove cushions before washing the wheelchair.
2. Clean the frame using water and a rag.
3. We recommend using soft soap.
4. Rinse the wheelchair well using clean water to remove all the soap.
5. Use methylate spirit to remove any dirt left.
6. Clean cushions and covers according to instructions printed on cushions.

NETTI CUSHION CLEANING PROCEDURES

CORE	
Washing	Hand wash 40° C
Disinfection	Virkon S
	Auto clave 105° C
Drying	Squeeze
	Air dry standing edgewise
OUTER COVER	
Washing	Machine wash 60° C
Drying	Tumble dry max. 85° C

DISINFECTION OF THE WHEELCHAIR

Remove cushions.

See separate washing instruction above:
Wipe disinfection: use a soft rag wetted with Hydrogen peroxide or technical alcohol (isopropanol) and wipe the whole chair clean. Hydrogen peroxide recommended: NU-CIDEX "Johnsen and Johnsen".

i Check / re-adjust screws and nuts at regular intervals.

i Sand and sea water (salt used for gritting in the winter) can damage the bearings of the front castors and main wheels. Clean the wheelchair thoroughly after use.

* As a rule of thumb, use oil on movable parts and all bearings. Alu Rehab recommends use of ordinary bicycle oil.

10.3 LONG TERM STORING

If the wheelchair is to be stored for longer time (longer than 4 months) no special actions are needed. We recommend that the chair is cleaned before storing. Before it being used again, complete the above maintenance instructions.

SPARE PARTS

The Netti chairs are built of modules. Alu Rehab carries stock of all parts and is ready to supply these on short notice. Necessary instructions for mounting will follow the parts.

Parts to be handled by user are defined in spare part catalogues that can be downloaded at www.My-Netti.com.

These parts can, if needed, also be removed and sent to manufacturer / distributor upon request.



Parts related to wheelchair frame construction must be handled by manufacturer or authorized service facility.



If defects or damages occur, please contact your dealer.



Original paint for repair of scratched, can be ordered from Alu Rehab.

11. TROUBLESHOOTING

Symptom	Reason / Action	Reference in manual
The wheelchair is going askew	<ul style="list-style-type: none"> The angle of the bearing house might not be 90°. Check that the front castors are fitted in the same height. The main wheel hubs might be incorrectly mounted. One of the brakes might be too tight. The user are sitting very askew in the chair The user might be stronger on one side than the other. 	<p>6.4</p> <p>6.3</p> <p>6.6</p> <p>6.17</p>
The wheelchair is heavy to manoeuvre	<ul style="list-style-type: none"> The main wheel hubs might be incorrectly mounted. Clean the front castors and forks for dirt. Too much weight over the front castors (Adjust the point of balance by moving the main wheels back). 	6.6
The wheelchair is hard to turn	<ul style="list-style-type: none"> Control that the front castors are not fixed too tight. Adjust the angle of the bearing house. Too much weight over the front castors adjust the point of balance. 	<p>6.4</p> <p>6.5</p>
The front castors are wobbling	<ul style="list-style-type: none"> The front castors are not fixed properly. Check that the front forks are fitted in the same height. The angle of the bearing house might not be 90°. Too much weight over the front castors adjust the point of balance. 	<p>6.4</p> <p>6.4</p> <p>6.3</p> <p>6.5</p>
The main wheels are difficult to take off and put on	<ul style="list-style-type: none"> Clean and grease the quick release. Adjust the length of the hub bushing. 	6.6
The brakes are not functioning well	<ul style="list-style-type: none"> Check the wheels and the distance to the brakes. Adjust the brake. 	6.17
The wheelchair feels "shaky"	<ul style="list-style-type: none"> Check screws and adjustment points in general. 	



Please contact your dealer for information about authorized service facilities that can give support if solution is not reached in this form.



When in need of spare parts, please contact your dealer.



When making changes affecting frame construction, contact dealer / manufacturer for confirmation.

12. TESTS & WARRANTY

12.1 TESTS

Netti III and Netti III HD are tested and have been approved for usage both indoors and outdoors. The chairs are Netti marked.

MAXIMUM USER WEIGHT:

135 kg for Netti III
with seat width 350-500 mm

160 kg for Netti III HD
with seat width 500-600 mm.

It is tested by
German accredited test laboratory according to
DIN EN 12183.

Netti III and Netti III HD are crash tested at RISE
(Research Institute of Sweden) and TÜV Rheinland
according to ISO 7176-19.

Both are approved for being used as a seat in a
vehicle.

MAXIMUM USER WEIGHT WHEN USED AS SEAT IN A CAR:

135 kg for Netti III
with seat width 350-500 mm

160 kg for Netti III HD
with seat width 500-600 mm.



Netti seating system is tested for fire resistance
according to: EN 1021-2.

12.2 WARRANTY

Alu Rehab is providing you with a 5-year warranty on all frame components and on the cross-tube assembly. There is a 2-year warranty on all other Netti labelled components except batteries. For batteries a 6 month warranty is provided.



Alu Rehab is not responsible for any damage resulting from inappropriate or unprofessional installation and / or repairs, neglect, wear, from changes in wheelchair assemblies or instructions not approved by Alu Rehab or by use of spare parts delivered or produced by third parties. In such cases, this warranty shall be considered null and void.



This warranty is only valid when the user use, maintain and handle the wheelchairs as described in this user manual.

12.3 CLAIM

If a product has developed a fault during the warranty period as result of a defect in design or manufacturing, you may forward a warranty claim.

- Claims are to be forwarded as soon as a defect is discovered and not later than 2 weeks after the defect is discovered.
- Claims are to be addressed to the sales agent of the wheelchair. Please note that sales documentation has to be filled in and signed correctly with serial number and eventual NeC number in order to document time and place of the purchase of the wheelchair.
- The sales agent and Alu Rehab are to decide whether a defect is covered by this warranty. The claimer will be informed about the decision as soon as possible.
- If the claim is accepted, the sales agent and Alu Rehab representative are to decide if the product will be repaired, replaced or if the customer is entitled to a reduced price.
- If a warranty claim is judged to be invalid - after careful inspection of the defect (defect due to wrong use and/ or lack of required maintenance) you are free to decide if you want to have the product repaired (if possible) at your expense, or if you want to purchase a new product.



Normal wear, incorrect use or incorrect handling is not a reason for claims.

12.4 NETTI CUSTOMIZED / INDIVIDUAL ADAPTATIONS

Netti Customized / individual adaptations are defined as all adjustments that are not included in this manual. Individual adaptations made by Alu Rehab are labelled with a unique NeC number for identification.

Wheelchairs that are especially adjusted / adapted by the customer cannot keep the CE mark given by Alu Rehab A.S Norway. If the adjustments are performed by other than Alu Rehabs approved dealers, the warranty given by Alu Rehab A.S Norway will not be valid.

If any uncertainty about special fitting and adaptations, please contact Alu Rehab A.S.



If you have different needs than what our standard wheelchair program can cover, please contact customer service for eventually special adjustments or Netti Customized solutions.

12.5 COMBINATIONS WITH OTHER PRODUCTS

Combinations of Netti and other products not manufactured by Alu Rehab A.S: Generally in these cases, the CE mark of all the products involved will not be valid. However, Alu Rehab A.S has made combination agreements with some manufacturers about some combinations. By these combinations the CE mark and warranties are valid.



For further information, please contact your dealer or Alu Rehab A.S Norway directly.

PRODUCT RESPONSIBILITY

Netti III and Netti III HD with different configurations of Netti equipment has been tested /risk evaluated by Alu Rehab.

Any alterations or substitutions must not be made to the wheelchair securement points or to structural and frame parts without consulting the wheelchair manufacturer Alu Rehab.

Substitutions or alterations of components from third part suppliers to Netti III requires the risk evaluation and acceptance of the product responsibility and safety for use of the wheelchair from the manufacturer that is performing the substitution or alteration.

12.6 SERVICE AND REPAIR

Information about service and repair services in your area, please contact your local dealer.



A unique identification number / serial number is to be found on the crossbar on the wheel frame on left side of the chair.



A spare part catalogue for the wheelchair can be obtained through your local dealer or downloaded at www.My-Netti.com



A refurbishment manual for the wheelchair can be obtained through your local dealer or downloaded at www.My-Netti.com



Information on product safety notices and product recalls are available at www.My-Netti.com



A recycling manual for the wheelchair can be obtained through your local dealer or downloaded at www.My-Netti.com

13. MEASUREMENTS & WEIGHT

Size*	Seat depth Standard**	Back height *** (Extender)	Total width	Weight
350 mm	400–500 mm	500 (600) mm	580 mm	31,0 kg
380 mm	400–500 mm	500 (600) mm	610 mm	31,6 kg
400 mm	400–500 mm	500 (600) mm	630 mm	32,0 kg
430 mm	400–500 mm	500 (600) mm	660 mm	32,6 kg
450 mm	400–500 mm	500 (600) mm	680 mm	33,0 kg
500 mm	400–500 mm	500 (600) mm	730 mm	34,0 kg
550 mm	400–500 mm	500 (600) mm	780 mm	36,5 kg
600 mm	400–500 mm	500 (600) mm	830 mm	39,0 kg

- * Dimension from outer edge to outer edge of frame tubes.
The distance between cloths protectors: ad 25 mm.
- ** Dimension from front edge of the seat plate to the back hinge – without cushion.
By correct placed UNO back cushion ca. 30 mm must be subtracted from this dimension.
- *** Dimension from seat plate to top of the back.



**Weight include main wheels, front castors, leg supports and arm supports.
The cushions are not included.**



Recommended tyre pressure for pneumatic tyres: 40–45 PSI.



**Max. user weight for Netti III with seat width up to 500 mm 135 kg.
When used as seat in a car: Max. user weight 135 kg.**

**Max. user weight for Netti III HD with seat width 350-600 mm 160 kg.
When used as seat in a car: Max. user weight 160 kg.**



**When accessories and extra equipment are mounted, the weight of them
must be subtracted from the max user weight.**



**Luggage loaded on to the wheelchair must not exceed 10 kg. The
luggage must not be placed in a manner that reduce the stability of
the chair.**

Dealer:	
Frame number.:	
Date:	
Stamp:	



Manufacturer:

📍 Alu Rehab AS
Bedriftsvegen 23
N-4353 Klepp Stasjon
Norway

✉ post.klepp@meyragroup.com
T: +47 51 78 62 20
my-netti.com

Distributor

Alu Rehab ApS
Kløftehøj 8
DK-8680 Ry
Dänemark

info.ry@meyragroup.com
T: +45 87 88 73 00
F: +45 87 88 73 19
my-netti.dk
