



Date _____ Customer code C- _____

Invoice address _____ Contact person _____

_____ Reference _____

_____ Other delivery address _____

Invoice address = delivery address Quote

The chair will be used as seat for car transport.

Basic price 2.585,- € Excl. VAT

Seat width D64035 350 mm
D64040 400 mm
D64045 450 mm
D64050 500 mm

Capacity Max. 135 kg
Seat height See page 9
Seat depth 425-500 mm adjustable by 25 mm per step (optional 375-450 mm with D64000)

D28002 Seat depth adjustment (Std: 500 mm) 425 mm 450 mm 475 mm 76,- €

D64000 **Short version CES+** (incl. 22" + 6" wheel) 324,- €

D28002 Seat depth adjustment (Std: 450 mm) 375 mm 400 mm 425 mm 76,- €

D22154 Side upholstery for armrest (reduces SW with 2 x 20 mm) 163,- €

D80913 Seat width extension kit (extends SW with 20 or 40 mm) 87,- €

= Standard equipment

Item	Description	Price in €
Standard <input checked="" type="checkbox"/>	Head support A, with side support	0,-
D26574 <input type="checkbox"/>	Head support B, oval	0,-
D26573 <input type="checkbox"/>	Head rest C, square	0,-
D26576 <input type="checkbox"/>	Head support D, comfort (pressure distributive)	260,-
D82567 <input type="checkbox"/>	Head support A with head band (not approved as seat for car transport – if this is needed please order an additional Netti headrest)	370,-
D82568 <input type="checkbox"/>	Extra comfort pads for the head band of D82567, pair	35,-
D64085 <input type="checkbox"/>	Drum brakes with quick release	271,-
D25059 <input type="checkbox"/>	Universal tray	243,-
D21052 <input type="checkbox"/>	Upholstery for tray	130,-
D86145 <input type="checkbox"/>	Side support Basic, pair	399,-

NORWAY: Alu Rehab AS | Bedriftsvegen 23 | N-4353 Klepp stasjon | post.klepp@Meyragroup.com | Phone +47 51 78 62 20

DENMARK: Alu Rehab ApS | Kløftehøj 8 | DK-8680 Ry | netti@Meyragroup.com | Phone +45 87887300

D20845	<input type="checkbox"/>	Hip belt, with upholstery and car belt lock	130,-
D21122	<input type="checkbox"/>	3D cover for the complete chair	195,-
D21076	<input type="checkbox"/>	Configuration for car transportation for users higher than 185 cm incl.: D41006 Back extender 600 mm (only in combination with Netti Smart, Stabil or Super Stabil cushion to receive a back cushion height 600 mm) D21054 Vertical tube for headrest - 500 mm D82025 Headrest adapter in aluminium	606,-

FRAME

Standard	<input checked="" type="checkbox"/>	Push handles 300 mm	0,-
Standard	<input checked="" type="checkbox"/>	Anti tip – swingable	0,-
Standard	<input checked="" type="checkbox"/>	User brakes, brake handle can be folded forward	0,-
Standard	<input checked="" type="checkbox"/>	Car fasteners – if an accessory means that the wheelchair is not approved for use as seat in a car, the chair will be delivered without car fasteners.	0,-
D86099	<input type="checkbox"/>	Brake lever extension +70 mm (length 200 mm) to be mounted by dealer	182,-
D27282	<input type="checkbox"/>	One-hand-brake, right (only in combination with drum brakes)	389,-
D27283	<input type="checkbox"/>	One-hand-brake, left (only in combination with drum brakes)	389,-
D81740	<input type="checkbox"/>	Push bow, height and angle adjustable	389,-
D28972	<input type="checkbox"/>	Anti tip with pedal, pair	216,-
D29474	<input type="checkbox"/>	Tilt restrictor (no negative tilt forward)	43,-
D28001	<input type="checkbox"/>	Frame extension including longer antitippers	324,-

BACK UNIT (please also see page 1 - for belts please see page 8)

Standard	<input checked="" type="checkbox"/>	Back cushion Netti Uno - with 100 mm side support - Easy Care cover	0,-
Standard	<input checked="" type="checkbox"/>	Back height 500 mm incl. one piece fabric back with cut out for easy mounting of side supports (available from 12/2025 as ongoing update)	0,-
D21137	<input type="checkbox"/>	Adjustable 6-piece back cover (mounting through local dealer)	294,-
D21138	<input type="checkbox"/>	Adjustable 6-piece back cover with cut for side supports (mounting through local dealer)	324,-
D21338	<input type="checkbox"/>	Back cushion Netti Smart – with 120 mm side support - Easy Care cover	357,-
D27375	<input type="checkbox"/>	Side support correction with upholstery right – for Netti Uno and Smart	228,-
D27374	<input type="checkbox"/>	Side support correction with upholstery left – for Netti Uno and Smart	228,-
D41006	<input type="checkbox"/>	Back extender 600 mm (only in combination with Netti Smart, Stabil or Super Stabil cushion to receive a back cushion height 600 mm)	240,-
D71335	<input type="checkbox"/>	Back cushion Netti Stabil – with 170 mm side support - Easy Care cover. Including the adjustable 6-piece back cover for optimum positioning (mounting through local dealer)	851,-

D71235	<input type="checkbox"/>	Back cushion Netti Stabil – with 170 mm side support - Easy Care cover. Including the adjustable 6-piece back cover with cut for side supports for optimum positioning (mounting through local dealer)	872,-
D71336	<input type="checkbox"/>	Back cushion Netti Super Stabil – with 170 mm reinforced side support - Easy Care cover. Including the adjustable 6-piece back cover for optimum positioning (mounting through local dealer)	945,-
D71236	<input type="checkbox"/>	Back cushion Netti Super Stabil – with 170 mm reinforced side support - Easy Care cover. Including the adjustable 6-piece back cover with cut for side supports for optimum positioning (mounting through local dealer)	966,-
D20631	<input type="checkbox"/>	Back cushion Netti Kyphotic only back height 500 mm in Stella/3D cover. Including the adjustable 6-piece back cover for optimum positioning (mounting through local dealer)	1040,-
D20632	<input type="checkbox"/>	Back cushion Netti Kyphotic only back height 500 mm in 3D/Stella cover. Including the adjustable 6-piece back cover with cut for side supports for optimum positioning (mounting through local dealer)	1061,-
D26831	<input type="checkbox"/>	Side support Stable left – for Netti Stabil, Super Stabil & Kyphotic	260,-
D26844	<input type="checkbox"/>	Side support Stable right – for Netti Stabil, Super Stabil & Kyphotic	260,-
D27541	<input type="checkbox"/>	Side support upholstery Stable, pair	163,-
		Libertas 15° back flexibility incl. long anti tips and frame extender (not approved as seat for car transport)	Price on request
		<input type="checkbox"/> D82411 80N <input type="checkbox"/> D82412 120N <input type="checkbox"/> D82413 160N	



SEAT UNIT (please also see page 1 - for belts please see page 7)

Standard	<input checked="" type="checkbox"/>	Seat cushion Netti Uno with Easy Care cover	0,-
D21048	<input type="checkbox"/>	Incontinence cover for seat cushion	249,-
D21777	<input type="checkbox"/>	Pressure relief seat cushion Netti Sit with Easy Care cover	411,-
D21017	<input type="checkbox"/>	Pressure relief seat cushion Netti Sit 3D/°C with temperature regulating features and incontinence layer under the 3D cover	574,-
D40001	<input type="checkbox"/>	Pressure distribution and relief seat cushion Netti Precision 1 Cover Stella +/- Easy Care + depending on the fabric for the whole chair Article number _____ <small>(If nothing is specified, Netti will select the appropriate size based on seat depth and seat width. For seat depth, we recommend a maximum difference of 30 mm, and we recommend longer cushion rather than shorter.)</small>	850,-
D40002	<input type="checkbox"/>	Pressure distribution and relief seat cushion Netti Precision 2 Cover Stella +/- Easy Care + depending on the fabric for the whole chair Article number _____ <small>(If nothing is specified, Netti will select the appropriate size based on seat depth and seat width. For seat depth, we recommend a maximum difference of 30 mm, and we recommend longer cushion rather than shorter.)</small>	1050,-
D40003	<input type="checkbox"/>	Netti Precision Incontinence cover – Change of cover for D40001/D40002. Breathable, elastic and durable. Transports liquid away from the skin and collects it in watertight space, so that the surroundings are not contaminated.	0,-
D27493	<input type="checkbox"/>	Abduction block small (W: 80 mm x L: 140 mm x H: 80 mm)	271,-
D27494	<input type="checkbox"/>	Abduction block medium (W: 110 mm x L: 150 mm x H: 80 mm)	271,-
D27495	<input type="checkbox"/>	Abduction block large (W: 140 mm x L: 170 mm x H: 80 mm)	271,-



LEG SUPPORTS

For the Netti 4U CE Plus you have 2 different types of leg supports with various accessories. Please contact us for consultation.

Manually angle adjustable leg supports

	Standard	■ Manually angle adjustable leg supports with -automatic length adjustment -angle adjustable foot plates -calf supports and knee upholstery	0,-
	D88211	<input type="checkbox"/> Leg support upper parts with lever instead of star wheel for angle adjustment	92,-
		Bodypoint ankle huggers with upholstery	
		<input type="checkbox"/> D44863 S (L: 170-200 mm)	249,-
		<input type="checkbox"/> D44864 M (L: 190-230 mm)	249,-
		<input type="checkbox"/> D44865 L (L: 220-290 mm)	260,-
		<input type="checkbox"/> D44904 XL (L: 280-330 mm)	281,-
	D21745	<input type="checkbox"/> Calf support bracket upholstery - pair - skai cover	65,-
	D41617	<input type="checkbox"/> Calf support upholstery extra soft - pair - EC or 3D cover depending on the fabric for the whole chair	228,-
	D23014	<input type="checkbox"/> Footfixation	151,-
	D21044	<input type="checkbox"/> Footboard with lock	336,-
	D28453	<input type="checkbox"/> Foot plate upholstery - pair - skai cover	314,-

Universal leg supports

	D24005	<input type="checkbox"/> Universal leg supports with knee angle adjustment, adjustable below 90° for contract leg situations with seat unit tilted when chair is pushed. Delivered without calf supports, but with heel straps.	141,-
			
		Bodypoint ankle huggers with upholstery incl. mounting kit	
		<input type="checkbox"/> D44863 S (L: 170-200 mm)	249,-
		<input type="checkbox"/> D44864 M (L: 190-230 mm)	249,-
		<input type="checkbox"/> D44865 L (L: 220-290 mm)	260,-
		<input type="checkbox"/> D44904 XL (L: 280-330 mm)	281,-
	D23014	<input type="checkbox"/> Footfixation	151,-
	D21044	<input type="checkbox"/> Footboard with lock (no heel straps)	336,-

ARM SUPPORTS AND ACCESSORIES

Standard	■	Removable arm rests, height and depth adjustable	0,-
Standard	■	Arm pads 385 x 58 mm	0,-
D41649	<input type="checkbox"/>	Arm pad upholstery extra soft, EC or 3D cover depending on the fabric for the whole chair (can only be combined with a swingable/ lockable tray together with tray spacers)	119,-
D21077	<input type="checkbox"/>	Arm pads 420 x 80 mm	130,-

D41650	<input type="checkbox"/>	Arm pad upholstery extra soft for D21077, EC or 3D cover depending on the fabric for the whole chair (can only be combined with a swingable/ lockable tray together with tray spacers)	141,-
D23003	<input type="checkbox"/>	Hemiplegic cushion	228,-
D22185	<input type="checkbox"/>	Arm support hemiplegic, left (can only be combined with a tray in special adaptation)	346,-
D22186	<input type="checkbox"/>	Arm support hemiplegic, right (can only be combined with a tray in special adaptation)	346,-
D23001	<input type="checkbox"/>	Lock for arm support (mounting through local dealer)	87,-



Decon E-Drive or Decon E-move

Push rim controlled drive unit and easy propulsion with joystick or attendant control – order directly by Netti together with the requested comfort wheelchair. Please use separate order form

MAIN WHEELS

Standard	<input checked="" type="checkbox"/>	Main wheels 24 x 1" PU, galvanized with quick release	0,-
D22007	<input type="checkbox"/>	Main wheels 22 x 1" PU incl. 6" front wheels	151,-
D22006	<input type="checkbox"/>	Main wheels wide: 1 3/8 PU infill	76,-
D22008	<input type="checkbox"/>	Main wheels pneumatic – only 24 x 1 3/8 available	76,-
D20834	<input type="checkbox"/>	One hand drive for 24" wheels PU – left (if mounted, the chair is not approved as seat for car transport and cannot be combined with drum brakes)	1.276,-
D20836	<input type="checkbox"/>	One hand drive for 24" wheels PU – right (if mounted, the chair is not approved as seat for car transport and cannot be combined with drum brakes)	1.276,-
INT70315	<input type="checkbox"/>	Main wheels 12½" PU with drum brakes – frame brakes are not compatible with the 12" wheels. Please contact us for an offer of a frame brake option. (Please note! Mounting of brake plates and handles for drum brakes is prepared by us, but the wheels are to be mounted by the dealer).	475,-
INT70316	<input type="checkbox"/>	Main wheels 16" PU with drum brakes. (Please note! Mounting of brake plates and handles for drum brakes is prepared by us, but the wheels are to be mounted by the dealer).	475,-
D22009	<input type="checkbox"/>	Hand- and spoke protector, pair (not for one hand drive)	163,-
D22013	<input type="checkbox"/>	Push rim cover, pair	130,-

FRONT WHEELS

Standard	<input checked="" type="checkbox"/>	Front wheels: 7" -175 x 33 PU	0,-
D21021	<input type="checkbox"/>	Front wheels: 7" – 175 x 45 PU wheel - puncture proof - with PU infill (necessary for supportive engines)	98,-
D21012	<input type="checkbox"/>	Front wheels: 7" – 175 x 45 pneumatic	98,-

HEAD SUPPORTS AND ACCESSORIES FOR HEAD SUPPORTS (please also see page 1)

D82025	<input type="checkbox"/>	Headrest adapter aluminium	260,-
D27577	<input type="checkbox"/>	Headrest E with adjustable side supports	336,-
D27578	<input type="checkbox"/>	Headrest F with cheek support (not approved as seat for car transport – if this is needed please order an additional Netti headrest)	336,-
D23004	<input type="checkbox"/>	Comfort cushion for head rest type C – removable with Stella cover	195,-
D23012	<input type="checkbox"/>	Easy Care cover for head rest type A, B, C – removable	98,-
D23013	<input type="checkbox"/>	3D cover for head rest type A, B, C – removable	98,-
D23015	<input type="checkbox"/>	Grey head rest cushion with Stella cover	249,-
D21064	<input type="checkbox"/>	Headrest adjustment tube (horizontal) + 50 mm, length 200 mm	98,-
D21027	<input type="checkbox"/>	Headrest adjustment tube (horizontal) + 100 mm, length 250 mm	98,-
D21065	<input type="checkbox"/>	Headrest adjustment tube (horizontal) + 150 mm, length 300 mm	98,-
D21028	<input type="checkbox"/>	Headrest adjustment tube (horizontal) + 230 mm, length 380 mm	108,-
D21054	<input type="checkbox"/>	Headrest adjustment tube (vertical) + 100 mm, length 500 mm	98,-
D26677	<input type="checkbox"/>	MYSeat head support (3 joints) Easy to adjust – Takes little space – Crash tested Artificial leather or textile cover depending on fabric choice for the whole chair. Multifunctional head support with adjustable sides. Horizontal, vertical and angle adjustable. Width 250 mm.	562,-
D90034	<input type="checkbox"/>	Extra joint for MYSeat head support extension – needed for back height 600 mm.	87,-



[A] [B] [C]

D45370	<input type="checkbox"/>	[A] Savant head support incl. headband, small – height 130 mm User forehead 460-560 mm User ½ circumference behind ears 150-180 mm Inside distance along top support 300 mm, along middle support 180 mm (not approved as seat for car transport – if this is needed please order an additional Netti headrest)	Price on request
D45371	<input type="checkbox"/>	[A] Savant head support incl. headband, adult – height 150 mm User forehead 560-610 mm User ½ circumference behind ears 200-300 mm Inside distance along top support 360 mm, along middle support 200 mm (not approved as seat for car transport – if this is needed please order an additional Netti headrest)	Price on request
D45373	<input type="checkbox"/>	[B] Side pads for Savant head support. For extra lateral support. For the upper arms of the head support. Cannot be combined with the headband	Price on request
D45375	<input type="checkbox"/>	Headrest adjustment tube (horizontal) +100 mm, length 250 mm	Price on request

D45368	<input type="checkbox"/>	[C] Axion head support rotary interface, permits a lateral rotation of 60°. Only for Savant headrests. (not approved as seat for car transport – if this is needed please order an additional Netti headrest)	Price on request
D45376	<input type="checkbox"/>	Axion head support rotary interface, permits a lateral rotation of 90°. Only for Savant headrests. (not approved as seat for car transport – if this is needed please order an additional Netti headrest)	Price on request
D89558	<input type="checkbox"/>	[C] Axion head support rotary interface, permits a lateral rotation of 60°. Only for Netti headrests. (not approved as seat for car transport – if this is needed please order an additional standard Netti headrest)	Price on request
D89559	<input type="checkbox"/>	Axion head support rotary interface, permits a lateral rotation of 90°. Only for Netti headrests. (not approved as seat for car transport – if this is needed please order an additional standard Netti headrest)	Price on request

TRAYS (please also see page 1)

D21050	<input type="checkbox"/>	Tray reinforced	411,-
D24001	<input type="checkbox"/>	Tray swingable	281,-
D24002	<input type="checkbox"/>	Tray lockable	281,-
D93316	<input type="checkbox"/>	Tray spacer for swingable or lockable tray – necessary if a tray is combined with soft upholstery for armpads D41649/D41650	21,-

VARIOUS ACCESSORIES

D21239	<input type="checkbox"/>	Tool kit	108,-
D41987	<input type="checkbox"/>	Intravenous rack	346,-

BELT OPTIONS FROM BODYPOINT AND NETTI

Belts and accessories for seat unit



D86282	<input type="checkbox"/>	Belt bracket kit – seat [A]	112,-
D20845	<input type="checkbox"/>	Hip belt, with upholstery and car belt lock [B]	130,-
D86902	<input type="checkbox"/>	Bodypoint 2-point pelvic stabiliser Evoflex incl. mounting kit [A+C]	288,-
D86891	<input type="checkbox"/>		
D86892	<input type="checkbox"/>		
D45273	<input type="checkbox"/>	Bodypoint 2-point hip belt incl. mounting kit [A+F]	260,-
D45274	<input type="checkbox"/>		
D45275	<input type="checkbox"/>		
D45040	<input type="checkbox"/>	Security cover for type [C], [D] and [F] in XS/M/L	76,-

		Bodypoint 4-point pelvic stabiliser incl. mounting kit [2xA+D]	436,-
D86889	<input type="checkbox"/>	XS (overall pad length: 360 mm)	
D86893	<input type="checkbox"/>	M (overall pad length: 460 mm)	
D86894	<input type="checkbox"/>	L (overall pad length: 620 mm)	
D60001	<input type="checkbox"/>	Abduction belt [E]	574,-
		Bodypoint supportive universal elastic strap	195,-
D45084	<input type="checkbox"/>	S (Height 80 mm - 1420 mm long, easily cut-to-length)	
D45085	<input type="checkbox"/>	L (Height 110 mm - 1420 mm long, easily cut-to-length)	
D45086	<input type="checkbox"/>	XL (Height 150 mm - 1420 mm long, easily cut-to-length)	



Belts and accessories for back unit

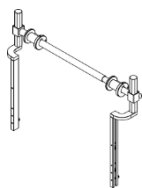

[A]



[B]



[C]



[D]



[E]

D86890	<input type="checkbox"/>	H-harness adaptor kit [A]	286,-
		For optimal ergonomics, position the h-belt adapter so the belt goes horizontally from fixation point over the top of the shoulders. This helps to maintain an optimal position (not being pushed down) and prevents shoulder strain. The push handles cannot be adjusted higher than the H-belt adapter itself, therefore, the H-belt adapter cannot be combined with push handles 500mm.	
D20881	<input type="checkbox"/>	H-belt, with upholstery and car belt lock [B]	271,-
D41645	<input type="checkbox"/>	Belt cross harness [C]	206,-
		Bodypoint Stayflex chest support without zipper [D]	282,-
D89805	<input type="checkbox"/>	XS (Shoulder width 240-280 mm)	
D89898	<input type="checkbox"/>	S (Shoulder width 380-330 mm)	
D86895	<input type="checkbox"/>	M (Shoulder width 330-410 mm)	
D86896	<input type="checkbox"/>	L (Shoulder width 410-480 mm)	
		Bodypoint Pivofit shoulder harness [E]	282,-
D89802	<input type="checkbox"/>	XS (Shoulder width 240-280 mm)	
D89803	<input type="checkbox"/>	S (Shoulder width 380-330 mm)	
D86898	<input type="checkbox"/>	M (Shoulder width 330-410 mm)	
D86899	<input type="checkbox"/>	L (Shoulder width 410-480 mm)	

TECHNICAL DATA

Tilt (seat)	-5° to +20°
Recline (back)	90° to 135°
Total width of the wheelchair	Seat width + 180 mm (std. wheels)/ + 195 mm (DB wheels) / +170 mm (12" + 16" DB wheels)
Total length	1020 mm with leg rests
Total height	1050 mm
Distance arm support to seat plate	Min. 270 mm/ max. 360 mm
Weight of wheelchair	App. 29 kg (without cushions)

Frame colour	Silver
Cover variant	Easy Care (optional 3D cover with D21122)
Crash test	ISO 7176-19 (135 kg)

Seat height – WITHOUT seat cushion (measured from floor to seat plate)

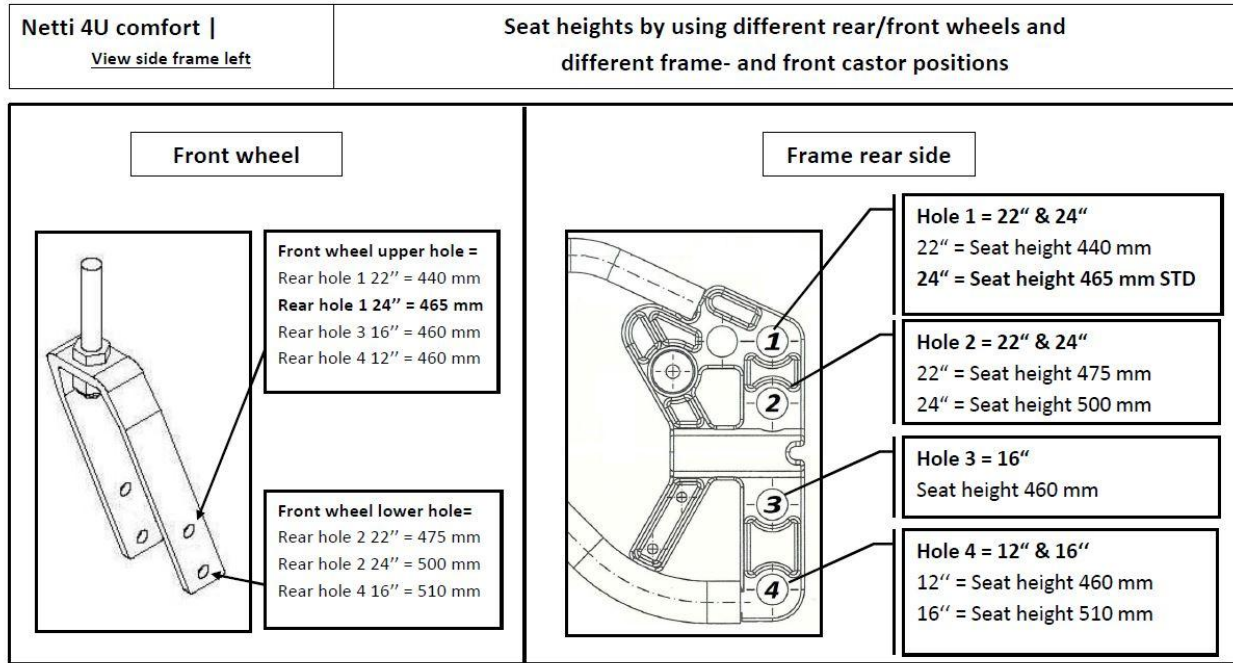

Leg rest type	Min. calf length	Max. calf length
Manual adjustable leg rests	320 mm	680 mm
Universal leg rests	360 mm	500 mm

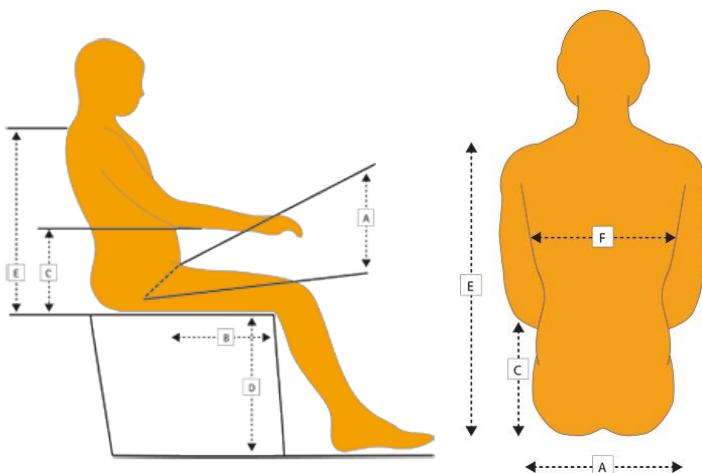

Measurements

- A Hip width/Seat width _____ mm
- B Thigh length / seat depth _____ mm
- C Arm rest height _____ mm
- D Leg length / seat height _____ mm
- E Backrest height _____ mm
- F Trunk width _____ mm