

 **Netti**[®] **GRANDIS** *LEG SUPPORTS*

Instruction for use



CE This product conforms to
2017/745/EU for medical products.

IFU0119 UK 2026-06

*inspire
joy of life*

CONTENTS

1. INTRODUCTION	4
IMPORTANT BENEFITS	4
HOW TO USE THIS MANUAL	5
NETTI GRANDIS ANGLE ADJUSTABLE LEG SUPPORT	5
2. ADJUSTING THE NETTI GRANDIS LEG SUPPORT TO THE USER	6
INITIAL ADJUSTMENTS	6
SEAT DEPTH ADJUSTMENTS = BALANCING THE CHAIR	6
SEAT DEPTH ADJUSTMENTS IN THE FRONT	7
SEAT ANGLE ADJUSTMENT	8
SEAT HEIGHT ADJUSTMENT	8
FOOT BOARD HEIGHT ADJUSTMENTS	8
AN ANGLE LIMITER	8
CALF SUPPORT HEIGHT ADJUSTMENT	9
CALF SUPPORT DEPTH ADJUSTMENT	9
CALF SUPPORT DEPTH SCALE	9
CALF SUPPORT ROTATION	10
CALF SUPPORT UPHOLSTERY	10
KNEE UPHOLSTERY	10
FOOT PLATE ANGLE ADJUSTMENTS	11
FOOT PLATE DEPTH ADJUSTMENTS	11
POSITIONING THE FOOT PLATE LOCK	11
FOOT PLATE LOCK	12
ANKLE HUGGERS AND SHOE SHELLS	13
LIFTING HANDLE	14
EXTENSION PIECE ADJUSTMENTS	14
LEG SUPPORT LOCK	14
EXTENSION PIECE ADJUSTMENTS II – LEG SUPPORT FITTING	14

3. EVERYDAY USE OF NETTI GRANDIS ANGLE ADJUSTABLE LEG SUPPORTS	15
MOUNT THE LEG SUPPORTS	15
REMOVE THE LEG SUPPORT	15
OPERATING THE FOOT PLATE LOCK	16
LEG SUPPORTS ANGLE ADJUSTMENTS	17
4. TRANSPORT	18
5. MAINTENANCE	18
6. TROUBLESHOOTING	18
7. TESTS & WARRANTY	19



1. INTRODUCTION

The Netti Grandis leg supports are developed providing long term wheelchair users the optimal leg support and also easy handling of the leg support for user and attendants.

The leg supports can be adjusted in a multitude of ways allowing individual configurations and adjustments.

The handling of the Netti Grandis leg support is developed to be intuitive and light. Knowing that the leg supports are the most handled components of the wheelchair, we have taken great care to make the handling easy.

We have developed a series of Netti Grandis leg supports models for different needs, all to be handled in practical the same manner.

IMPORTANT BENEFITS

- The leg supports will help the user to get and keep a good sitting position with good pressure distribution.
- The user will have less discomfort with correct adjusted leg supports.
- Tilt and recline functions can be used without the legs losing contact with the leg supports due to the functional pivot centre being aligned with the knee joint.
- The Netti Grandis leg supports are slim to give extra space for legs and feet.
- They can be adjusted from vertical to more than horizontal angle.
- Scales on several adjustment features make it easy to define and register the user configuration.
- They are well rounded with no sharp edges.
- The leg supports Grandis are light weighted.
- They have easy to operate locks securing extra stability in use.



NETTI GRANDIS LEG SUPPORT FAMILY:

- Netti Grandis angle adjustable leg supports
- Netti Grandis amputation leg support
- Netti Grandis foot box
- Netti Grandis fixed leg support

Please study this manual to get the information of how to do the adjustments and how to operate the leg supports in daily use.

HOW TO USE THIS MANUAL

This manual focuses on the adjustments and use of the Netti Grandis angle adjustable leg support. It is to be used together with the instruction for use of the wheelchair where they are installed, for general information.

The following symbols are used to point out important points:

 **Symbol of forbidden actions.**
No warranty can be claimed whenever these actions are implemented.

 **Symbol of warning.**
Whenever this symbol is used, caution has to be taken.

 **Symbol for important information.**

 **Symbol for useful tips.**

 **Symbol for tools.**

NETTI GRANDIS ANGLE ADJUSTABLE LEG SUPPORT



- 1 Leg support knee pivot cover
- 2 Leg support lock
- 3 Leg support bolt
- 4 Leg support knee upholstery
- 5 Calf support plate
- 6 Calf supports arm
- 7 Angle adjustable arm
- 8 Angle adjustable lock
- 9 Angle adjustable limiter
- 10 Lifting handle
- 11 Height adjustment screw
- 12 Ankle hugger bracket
- 13 Foot plate angle adjustment
- 14 Foot plate depth adjustment
- 15 Foot plate
- 16 Foot plate lock

2. ADJUSTING THE NETTI GRANDIS LEG SUPPORT TO THE USER

To achieve the best support and also the most easy handling it is vital to do the proper and accurate first time seating adjustments.

INITIAL ADJUSTMENTS

Start with normal relaxed seating position. The aim is to have **the centre of the users knee joint aligned with the centre of the leg support knee rotation centre** – while the user at the same time is having good back support of his lower back – even when the leg support angle is changed. With this in mind start with:

SEAT DEPTH ADJUSTMENTS = BALANCING THE CHAIR

 It is vital to adjust the seat depth correct. Adjustments to the seat depth change the centre of gravity which effects the balance of the wheelchair. Centre of gravity too far back = the wheelchair tips easily backwards. Centre of gravity too much forwards brings too much weight to the front castors and it is very heavy to drive and steer the wheelchair. Proper adjusted seat provide stability and good manoeuvrability of the wheelchair.

 **Correct seat depth:**
Loosen the Velcro straps of the back support. Check that the user is getting into the chair firmly. Adjust the back support by pulling the straps of the Velcro. The knees of the user should align with the joint of the leg support both in height and in depth – with 2 finger widths distance between seat of the users leg.

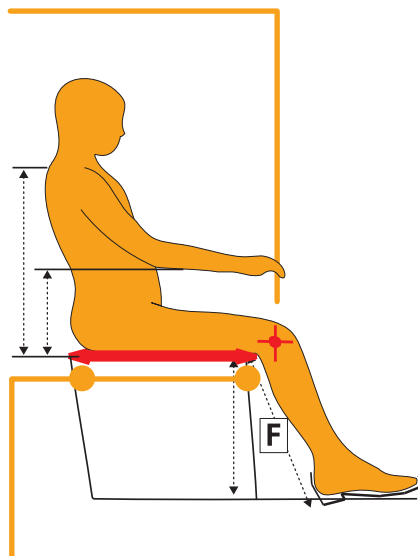

 The seat depth can be adjusted in several locations and directions:
The chair-back hinge can be repositioned to adjust seat depth backwards.
Extension pieces allow for increasing the seat depth in the front.
Consider the wheelchair balance. See further information to seat depth adjustment on the next page and in wheelchair instruction for use.

SEAT DEPTH ADJUSTMENTS IN THE FRONT:

are done by adjusting the extension pieces where the leg supports are mounted. The extension pieces are adjusted by removing the screws holding them and pulling the extension pieces out to desired position.

 The aim is to have the centre of the users knee joint aligned with the center of the leg support rotation centre – while the user at the same time is having good back support of his lower back – also when the leg support angle is changed.

 Always do seat depth adjustment both in front and back to balance the chair.

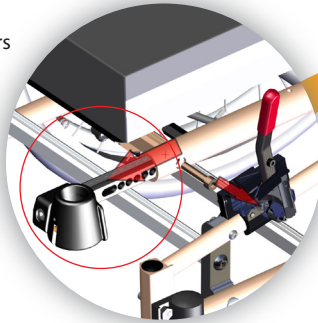

SEAT ANGLE ADJUSTMENT

The seat angle can be adjusted at any time by the use of the tilt handles.

SEAT HEIGHT ADJUSTMENT

- The seat height must always be seen together with the leg support length. Please find the description of seat height adjustment in the wheelchair manual.
- The leg support length must be adjusted to fit the user lower leg length. The seat height must be adjusted to have 20 – 30 mm minimum distance between foot boards and the floor when the leg supports have correct length.

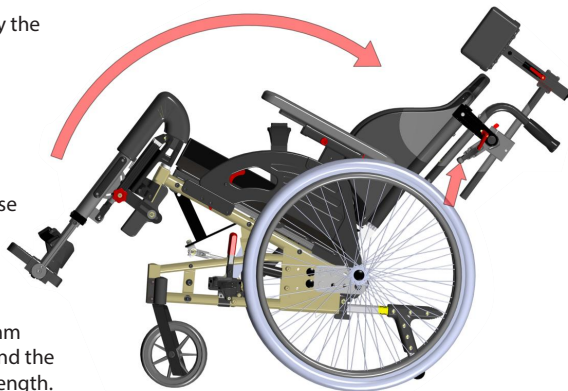

FOOT BOARD HEIGHT ADJUSTMENTS

Adjust the length of the leg support according to the leg length F (pg. 5) measured by 90° bent knee – measured from underside thigh to underside of shoe heel.

Loosen the screw holding the vertical inner aluminum profil – 2 turns – and pull or push to desired length.

 Do not unscrew completely to avoid tricky mounting.

 Tighten well at desired height. Make sure there are minimum 20 – 30 mm free space under the foot plates to go clear floor obstacles – minimum 30 – 40 mm when driving outside.

A scale on the inside of the inner vertical aluminum profile allows easy height registration and equal adjustment on both leg supports.



AN ANGLE LIMITER

-  on the outer leg support profile can be moved to adjust the most downward angle the user shall get. Loosen the screw and push the limiter to desired position before tightening.



CALF SUPPORT HEIGHT ADJUSTMENT

Loosen the screw on the inside of the calf support arm and push the calf support to a height where the calf gets most support. In addition to supporting the calf, they also help prevent the feet sliding backwards from the footboard.



Always position the calf supports in a height that do not cause conflict with seat-plate or foot-plates.



For chair widths 430-600 mm where the high version of calf support is used, there is a possibility for conflict with heel or seat plate when the leg support is adjusted for short leg length."



CALF SUPPORT DEPTH ADJUSTEMENT

- Loosen the screw holding the calf support pad on the side and adjust the depth.
- Position the calf pad backwards or forwards till it barely touches the user's calf with his / her feet resting on the footboard.
- The feet should stay on the middle of the footboard giving most support to the feet.

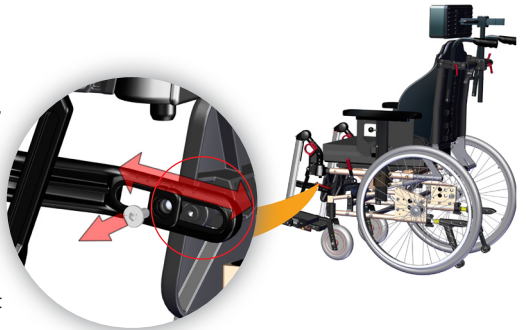

CALF SUPPORT DEPTH SCALE



On the calf support arm there is a scale that makes it easy to register and to adjust both calf supports to the same depth.

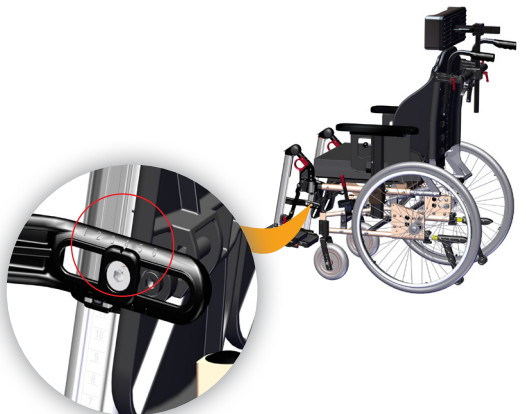

CALF SUPPORT ROTATION

The calf support rotation limiter allows for the calf support to follow the calf without unintentionally rotating too far.



CALF SUPPORT UPHOLSTERY

The thin and ergonomically shaped calf support pad allows for maximum free space for the legs and calfs.

There are calf support upholstery pads available as accessory when required.

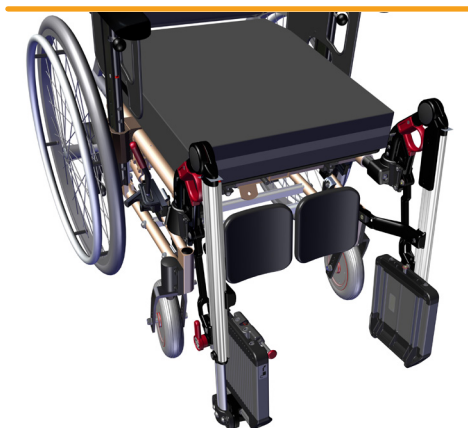

KNEE UPHOLSTERY

Netti GRANDIS leg support can be equipped with PU soft pads for knee pivot joint and knee upholstery. The soft knee pivot joint pad is clipped to the leg support.

The soft knee PU upholstery pad is fixed to the vertical leg support profile by 2 screws fixing to the 2 square nuts sliding in the vertical profile.

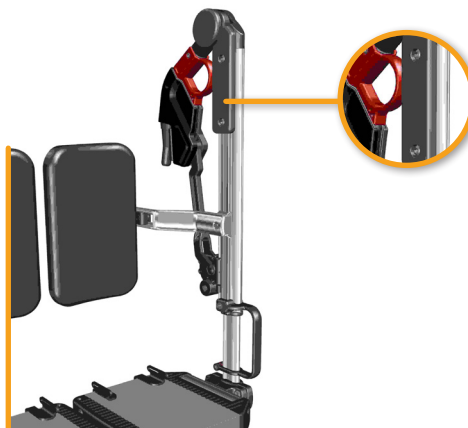

FOOT PLATE ANGLE ADJUSTMENTS

- Loosen the 2 screws on the outside of the foot plate bracket and tilt the foot plate to desired angle.
- Tighten well. The foot plate shall give stable support to the foot of the user.
- If you need to tilt in opposite direction: unscrew the 2 screws and move the nuts in the backside to the other 2 holes available and fix the screws again. This will give a negative foot plate tilt.



FOOT PLATE DEPTH ADJUSTMENTS

- Unscrew the 2 screws for foot plate angle adjustment and remove the complete foot plate from the bracket.
- Loosen the 2 inner screws now visible on the foot plate bracket and move the foot plate forwards or backwards to required depth.
- Tighten the screws and mount the foot plate back to the bracket it was fixed to before. +/- 30 mm on each foot plate is available.



POSITIONING THE FOOT PLATE LOCK

-  If you have adjusted the foot plate depth, or have adjusted the leg support extensions pieces to different depths, the foot plate lock needs to be repositioned. The foot plate lock and the foot plate lock bolt has to align with the centre line between the 2 footplate brackets.



FOOT PLATE LOCK

The foot plate lock is mounted with 2 screws to the foot plate.

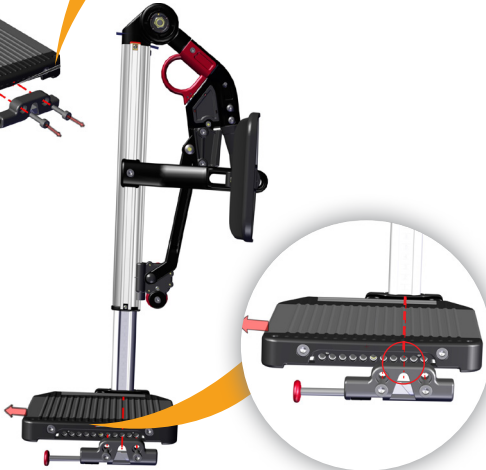

 The centre of the lock must be aligned with the centre line here marked red dotted.

 Dependent on where the lock is mounted, the lock pin must be adjusted in the length.

- The front button of the pin shall be positioned just behind the foot plate front.
- Unscrew the screw holding the pin and adjust the length.
- Fix the screw tightly – the screw hits a screw hole when you can see one hole on each side of bracket where the screw sits.

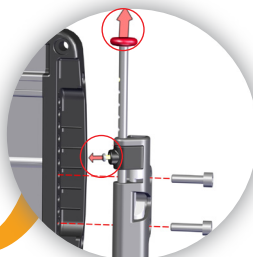
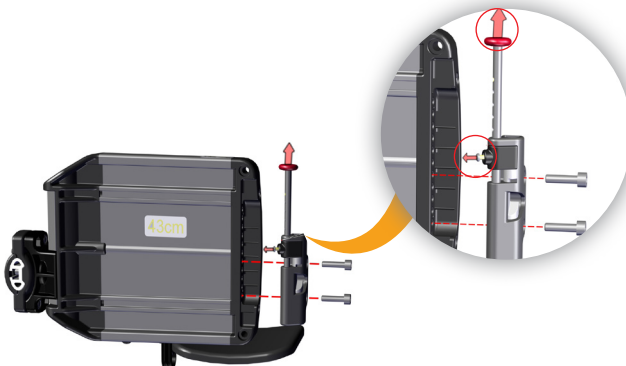

ANKLE HUGGERS AND SHOE SHELLS

helps to keep the feet on the leg support not letting them slide of the foot plate.

The ankle huggers are mounted to the foot plates, fixing the ankle hugger brackets 88658 on the underside of the foot plate – in the profile slots.



Mounting ankle hugger brackets to the foot plate: Insert square nut into slot and fix the bracket as shown:

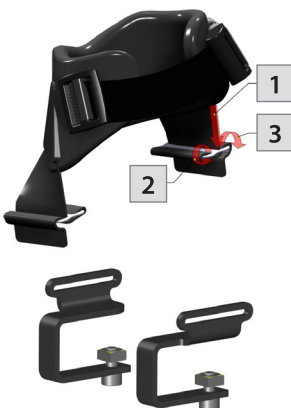

Ankle hugger to be threaded as shown in drawing.

Ankle hugger brackets 88658 – 2 pc for each foot plate.

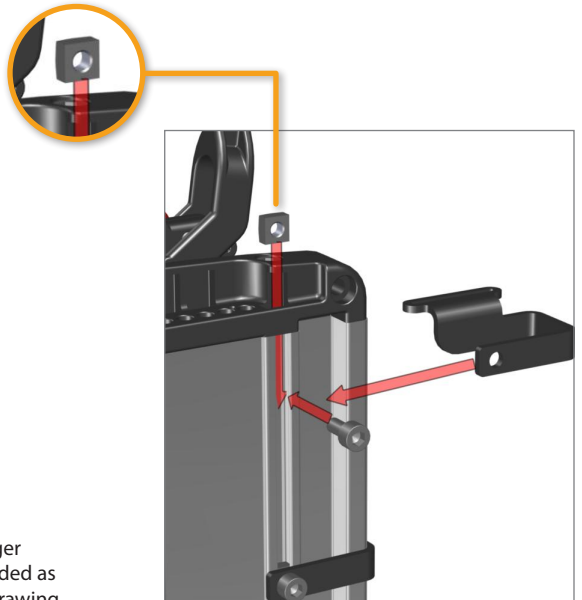

LIFTING HANDLE

You can adjust the height of the lifting handle by losing the screw at the inside of the leg support.

Adjust the handle to the maximum downwards in case the user has a lower leg length between 460 – 640 mm.

Adjust the handle to the maximum upwards in case the user has a lower leg length between 360 – 460 mm.

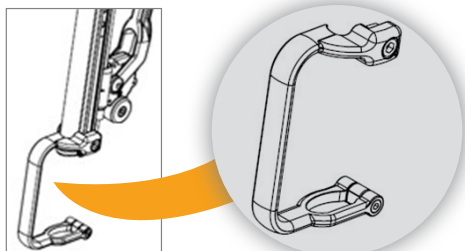



EXTENSION PIECE ADJUSTMENTS

At the extension pieces are two areas where you can adjust the exact leg support connectivity:

LEG SUPPORT LOCK

At the front end you will find a cylinder you need to adjust to assure the lock of the leg support in the extension piece conical socket.

 Use an Allen-key No. 3 to screw the bolt of the cylinder at the bottom side (see X in picture) to the most upwards position.

 Test the lock function by inserting the leg support to the extension piece and swing the leg support inwards. If you can hear a “Click” and the leg support cannot be moved, the leg support is locked. If not, please adjust the screw until the lock function is working properly.

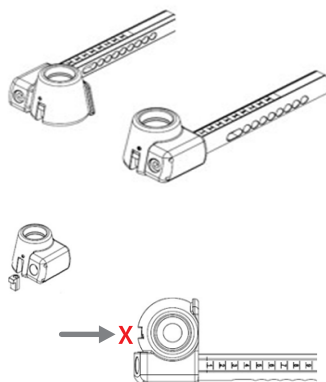

EXTENSION PIECE ADJUSTMENTS II – LEG SUPPORT FITTING

Inside of each extension piece there are 2 set screws. With an Allen-Key No. 2,5 you can adjust the play of the leg support by unscrewing them a little. Adjust both screws to a position where the leg support will have no side movement when it is locked in the conical extension piece.

 Please note: if the screws have been unscrewed too far the leg supports will not lock.



3. EVERYDAY USE OF NETTI GRANDIS ANGLE ADJUSTABLE LEG SUPPORTS

MOUNT THE LEG SUPPORTS

to the wheelchair by inserting the leg support bolt into the conic shaped holder on the wheelchair. It clicks into position and is fixed.

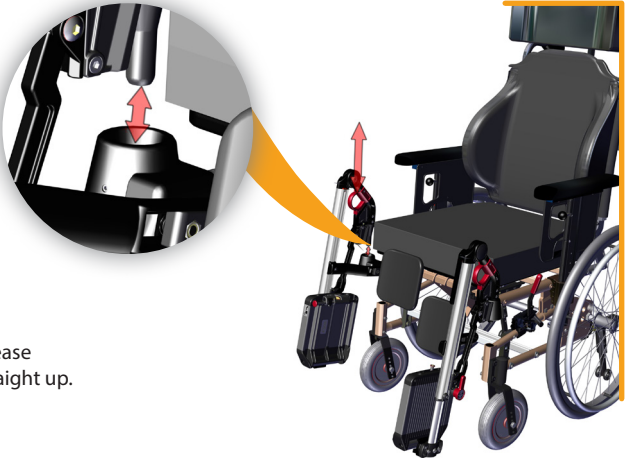
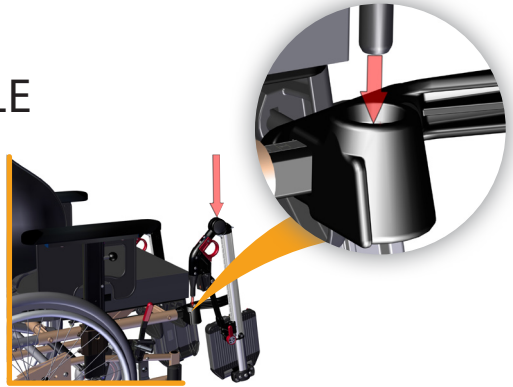

REMOVE THE LEG SUPPORT

by gripping through the round red release lock handle and lift the leg support straight up.

With the foot plates folded up, there is free space for transfers.

The foot plates folds down from the left and are locked to each other with the foot plate lock; this gives a sturdy platform for the feet.



OPERATING THE FOOT PLATE LOCK

The one hand foot plate lock is operated by pushing the lock button with the right hand thumb while holding under the foot plate with the other fingers.

The right foot plates unlocks and can be folded up while you can use your left hand to lift the right leg of the user.

The foot plates also locks into upright position.



The leg supports can swing 90 degrees outwards and gives free space without being removed. Simply pull the leg support lock – the red circular grip – and swing the leg support outwards. It clicks into lock when you swing in back to forward direction.



LEG SUPPORTS ANGLE ADJUSTMENTS

The one hand angle lock on the side of the leg supports is opened by turning it forwards as shown.

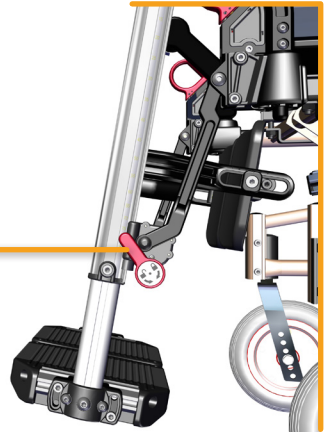

It will stay in this position and you are free to swing the leg support to required angle before you push the lock and it clicks into firmly held position.



On the outer aluminium profile there is a scale that shows which leg support angle you have chosen.

The leg support angle is locked when the lock handle is parallel to the aluminium profile.

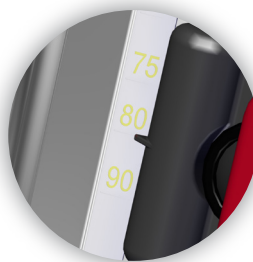

4. TRANSPORT

Wheelchairs with Netti Grandis angle adjustable leg supports can be used as seat in a car if the wheelchair itself has been tested and approved to ISO 7176-19. Please follow the description for fixing the chair and the user as described in the Instruction for use for the wheelchair.



The Netti Grandis leg support has to be locked when the wheelchair is used as a seat in a car.



Never lift the wheelchair holding on to the leg supports.

DRIVING A WHEELCHAIR



Pay attention not to hit into obstacles with the wheelchair and the leg supports as this may harm and hurt the user. It may also damage the wheelchair and the leg supports.

5. MAINTENANCE









Follow the wheelchair maintenance description in the wheelchair instruction for use and pay special attention to tightening all screws and inspecting all joints regularly.

6. TROUBLESHOOTING



Please study the recommendations in the Instruction for use for the Netti wheelchair where the Netti Grandis angle adjustable leg support are used.

7. TESTS & WARRANTY

-  Netti Grandis leg supports have been tested on several different Netti wheelchairs - both crash tests according to ISO 7176-19 and durability tests according to wheelchair manual wheelchair standard EN 12183.
-  Netti Grandis leg supports are manufactured following the Alu Rehab quality system according to ISO 13485.
-  The guarantee claims stated in the Instruction for use for the wheelchair also applies for Netti Grandis angle adjustable leg support.
-  Contact your local dealer if you have questions regarding Netti Grandis angle adjustable leg support or other Netti products.
-  Updated data about the wheelchairs and accessories are found on my-netti.com
-  Any serious incident that has occurred in relation to the device should be reported to the manufacturer and the competent authority of the Member State in which the user and/or patient is established.

Manufacturer of Netti:

 Alu Rehab AS
Bedriftsvegen 23
N-4353 Klepp Stasjon
Norway

 post.klepp@meyragroup.com
T : +47 51 78 62 20
my-netti.com