

Installation instruction

Universal device rack

Version 04-2024

for Netti III, Netti HD, Netti III XHD & Netti V

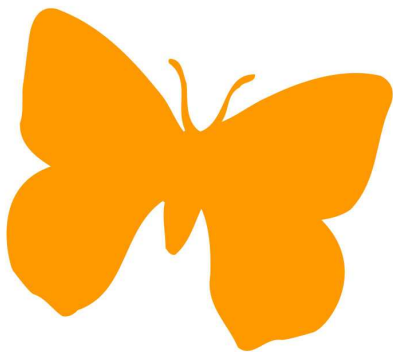

In December 2015 we have released a new version of our universal device rack where we made some design changes.

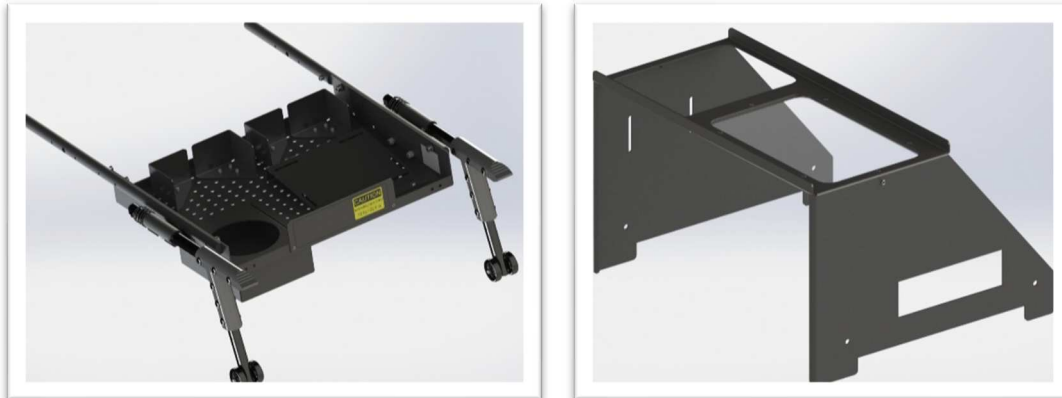

The Universal device rack can now be used also for oxygen containers (LOX-System) like we see here in picture 1.

The design change covers also the use of the bottle system (picture2)

New container system



Picture 1

Bottle system



Picture 2

The hole to keep the oxygen devices in position is square and has a cover plate which can be turned with 180° to use both round and square devices.

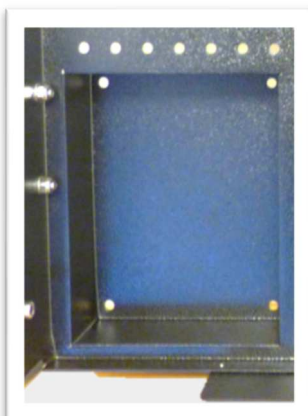



Contents:

1. Introduction to the universal device rack and protective cover / second level
2. Assembling the mounting tubes to the frame
3. Positioning the support rackets
4. Installing the anti-tips - see warning
5. Adjusting the anti-tip supports
6. Installing the optional protective cover
7. Installing an oxygen cylinder
8. Images of a fully assembled universal device rack
9. Retrofitting a universal device rack to an existing Netti III
10. Dimensions and data
11. Basic configuration of the Netti V / III / HD / XHD for use with the universal device rack
12. Maximum loads
13. Important notes for user and carers
14. Instructions and advice for use of a wheelchair together with the universal device rack

**Warning: the anti-tips must be turned and locked downwards
whenever the rack is mounted on a wheelchair**



**Warning: the wheelchair with Universal device rack is NOT approved
for being used as a seat in a vehicle!**



The following pictures in this manual showing the old type of the universal device rack.
The function and installation procedure remains the same after the design change.

The dimension after the design change have changed. Please have a look at page 9 to get the actual sizes.

The universal device rack is supplied pre-assembled and ready to install on a **Netti III Comfort HD / Netti III Comfort XHD and Netti V** wheelchair. It is intended to carry medical equipment.

Before you start to install the rack please read these instructions carefully.
For mounting the universal rack on a Netti V please read chapter 2.a.

After the rack has been installed this manual must be given to the wheelchair user. The user must be warned of the risks of using this rack if the anti-tips are not turned downwards and locked into position.

If you have received this rack for retrofitting to an a wheelchair that is already in use you should first read sections 9 and 11.

1. Introduction to the universal device rack and optional protective cover / second level:

- A** Platform
- B** Support tubes (for mounting to the wheelchair)
- C** Anti -tip supports
- D** Anti-tips
- E** Set of 4 adjustable retaining brackets
- F** Protective cover / second level
- G** Inclined support plate for a respiratory device
- H** Cut-out for oxygen cylinder
- I** Oxygen cylinder holder
- J** Inspection cut-out

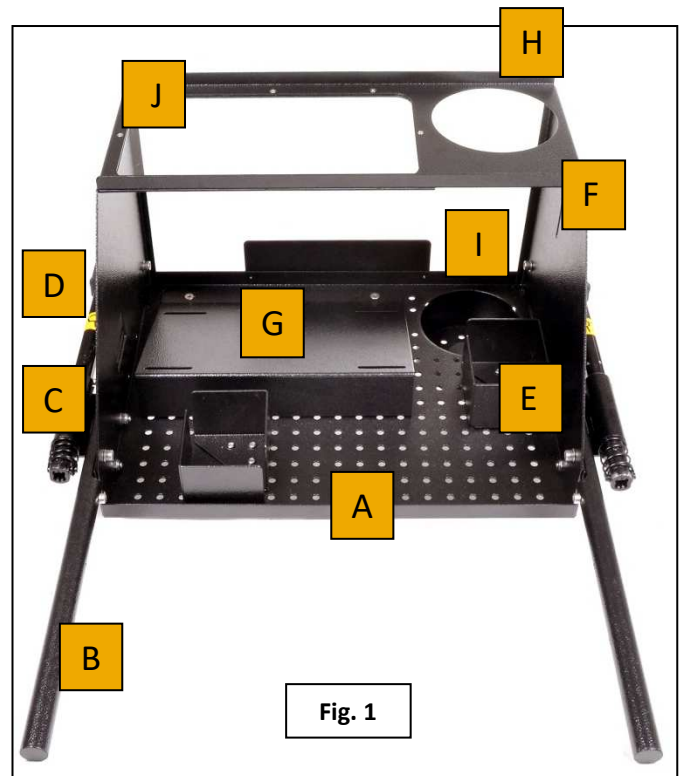

Fig. 1



2. Installation on Netti III / HD / XHD

The support tubes have 3 alternative M5 mounting positions for different seat depths (see Fig. 2)

Position 3 for seat depth: 50 – 57.5 cm
 Position 2: for seat depth: 45 – 47.5 cm
 Position 1: for seat depth: 40 – 42.5 cm

Slide the left and right support tubes into the support sleeves on the wheelchair frame for the standard anti-tips and secure them using the mounting holes shown in Fig. 3 using the M5 screws provided.

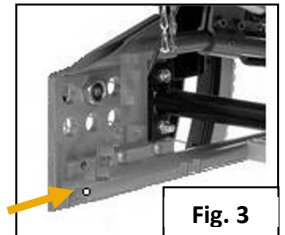
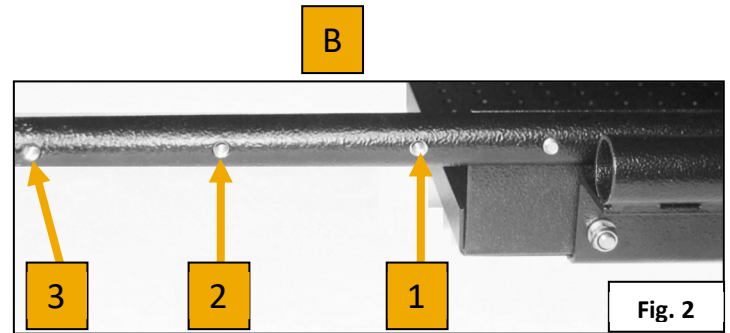

2.a Installation on a Netti V

Remove the anti-tips by unscrewing the two M8 screws on both sides, then mount the Netti V device rack bracket with the new M8 screws. Place the device rack on top of the bracket and insert and tighten all eight M6 screws with washers and nuts.

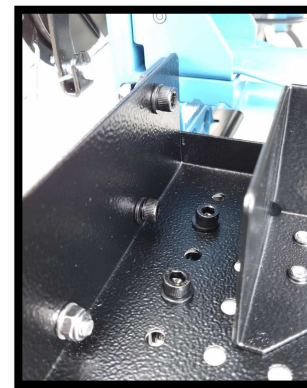

3. Positioning the retaining brackets

The platform (Fig. 4) allows the retaining brackets (Fig. 5) to be mounted in any position. Undo the 3 screws holding each bracket, position the brackets to suit the device involved and screw them into place, Fig. 6. Foam can be used to fill any gaps between the device and the brackets. The anti vibration pads, Fig. 7, provided, can be fixed to the bottom of the device. An additional set of 4 retaining brackets can be ordered under option number D42900.

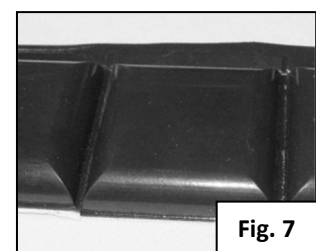
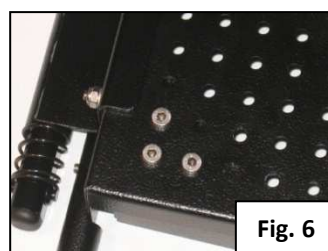
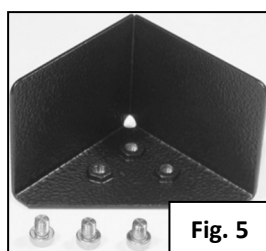
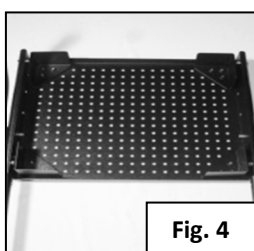

4. Installing the anti-tips D

WARNING the anti-tips are mounted at the factory. They should not normally be removed.

If necessary, slide the anti-tips forward, Fig. 8 from the rear of the rack into the anti-tip supports Fig. 9. Slide the springs provided Fig. 10 over the anti-tips. Compress each spring slightly and secure it by pushing the pin provided through the hole. The anti-tips are now mounted securely.

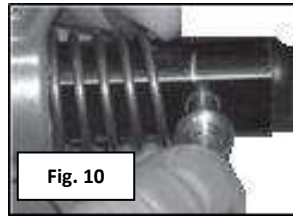
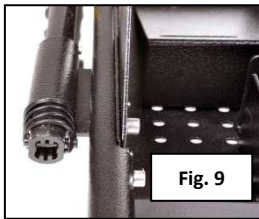
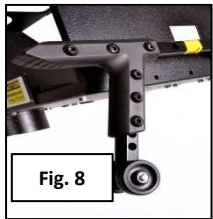

WARNING:

If the seat height has been increased, (see diagram), the standard anti-tips must be replaced by extra-long anti-tips – part # 25423

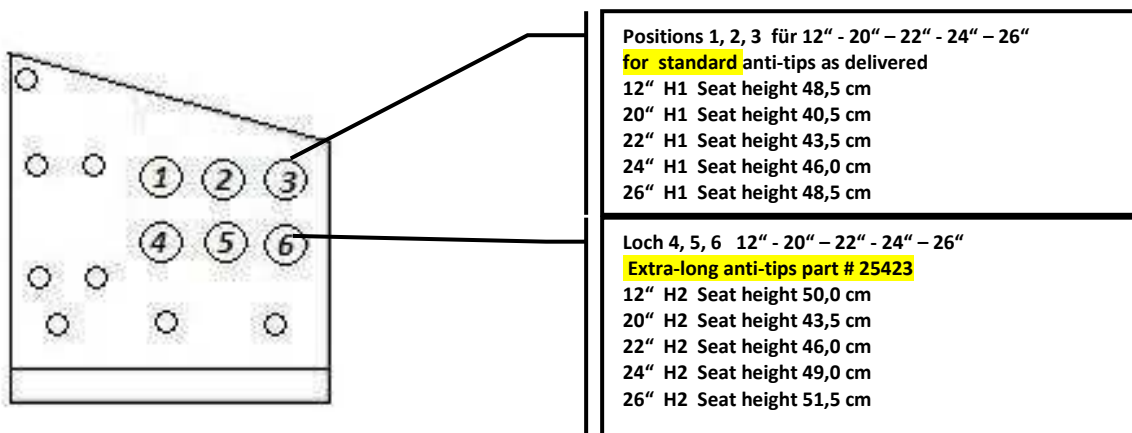

5. Adjusting the anti-tips C

If required the anti-tips can be moved forward. This is done by changing the position of the anti-tip supports. To do this unscrew, the M6 nuts that secure the anti-tip supports and remove the screws, Fig. 11. Slide the anti-tip supports forward and insert the screws into the 2 empty fixing holes, Fig. 12. Using 2 new self-locking nuts, tighten the screws firmly.

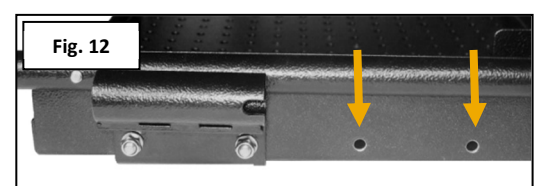
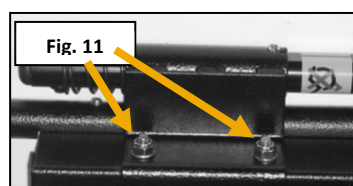

6. Installing the protective cover / second level

F

The protective cover is available as an option at additional cost.

The protective cover can be used as an upper platform (Fig. 13) can also be used to support additional light-weight devices with a total weight of up to 4 kg.

2 cut-outs are available, one for inspection, the other for the oxygen cylinder. Each cut-out has a plate that is secured by a side screw. You can remove the plate if you remove the side screw (Fig. 14).

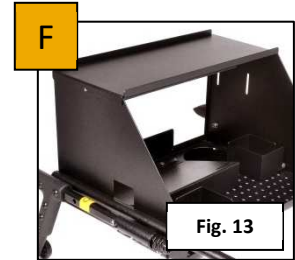

Fig. 13



Fig. 14



Loosen the 2 M6 screws on the inside of the platform. There is one at the back, (Fig. 16) and one at the front (Fig. 17). Pull the screws out. Place the protective cover on the platform so that the side panels are inside the raised edges of the platform (Fig. 18 & 19) and the sloping edge of the protective cover faces the wheelchair (Fig. 25). Screw the side panels together with the platform and the support tubes.

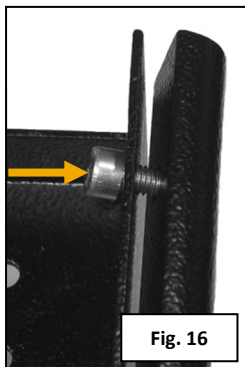

Fig. 16

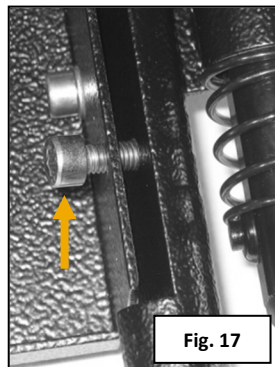

Fig. 17

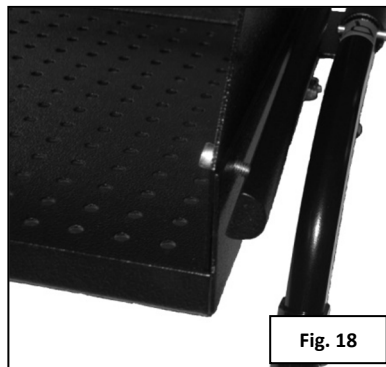

Fig. 18

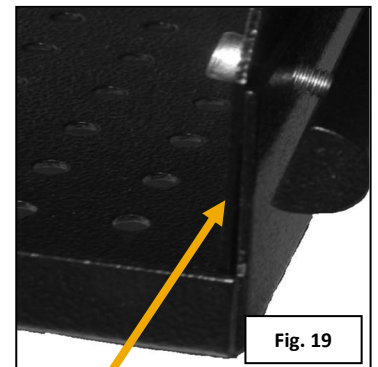

Fig. 19

Place the side panels of the protective cover inside the raised edges of the platform



Warning do not exceed the maximum load on the protective cover of 4kg

7. Installing an oxygen cylinder (requires the optional second level)

When fitted with the optional protective cover the universal device rack can hold a standard 2 l oxygen cylinder.

Remove the plate from the round 119 mm cut-out in the protective cover Fig14 & Fig. 20

Line the cut-out with the beading provided, see Figure 20.

This reduces the inner diameter to 115 mm.

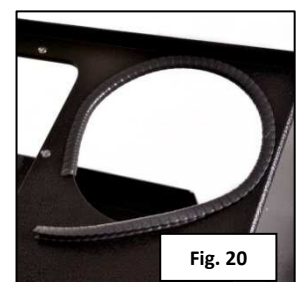
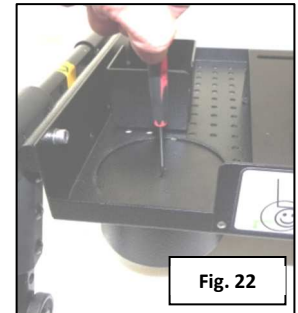

Fig. 20

The platform has a circular 115 mm diameter holder that is protected by a plate see Fig. 21.



Unscrew the screw in the centre of the plate, you can now remove the it. You may need to prise plate out (fig. 22)



Put the oxygen bottle in the holder. Velcro strips are supplied to fasten it to the slots in the side panels, figs 23 & 24



8. Images of a fully assembled universal device rack (Figs 25 & 26)

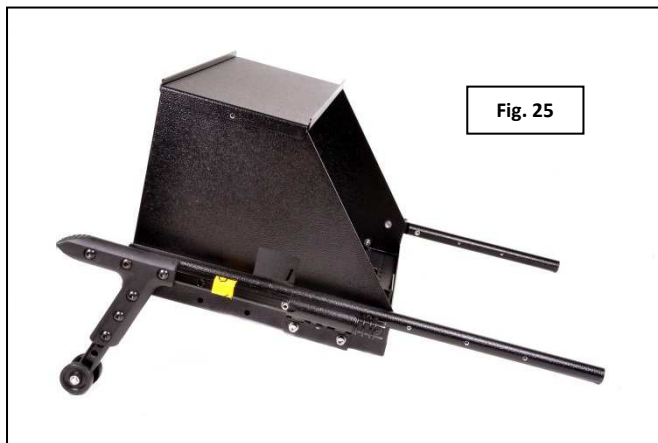

An optional set of 4 retaining brackets is available

9. Retrofitting a universal device rack to an existing Netti III HD/XHD

Remove the anti-tips:

Unscrew and remove the screw shown in Fig. 27 on the lower frame. This frees the retaining spring inside the tube.

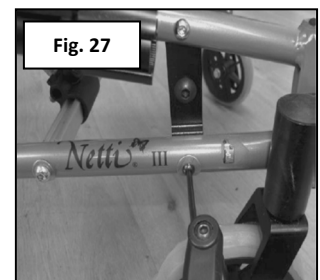

Now pull the entire anti-tip mechanism out of the back of the tube.

Put the screw back and tighten it and continue from section 2 of this manual.

10. Dimensions and data

Universal device rack

Depth: 348 mm

Width: Seat width less 36mm

Edge height of retaining brackets: 60 mm

Maximum load 10 kg

Material: Aluminum powder coated in black

Protective cover

Depth: 193 mm

Width: Seat width less 37mm

Height: 237 mm (free space)

Ready for a 2 l oxygen cylinder with a 115 mm diameter holder in platform and a cut-out in protective cover or a LOX container.

Universal device racks and protective covers are available only for the following wheelchairs

Netti III HD in seat widths of 35, 38, 40, 43, 45, 50, 55, & 60 cm

Netti III XHD in seat widths of 50 & 75 cm

Netti V 35, 40, 45, 50, 55 cm

11. Basic configuration of the Netti III HD / XHD for use with the universal device rack

The universal device rack is compatible with Netti III Comfort HD / Netti III Comfort XHD and Netti V wheelchairs when equipped with the following accessories.

- Wheelbase extension
- 2 reinforced wheels (not necessary for Netti V)
- Seat tilt with 2 gas springs (not necessary for Netti V)

12. Maximum load

Please note that the entire load on the wheelchair including the user, any accessories, the universal device rack, and other equipment, must not exceed 160 kg.

13. Important note

A copy of these installation and operating instructions must be given to the user of the wheelchair and their carers.

Warning, make sure that the anti-tips are always swung downwards and locked while the chair is being used.

The wheelchair with Universal device rack is not approved for being used as a seat in a car.

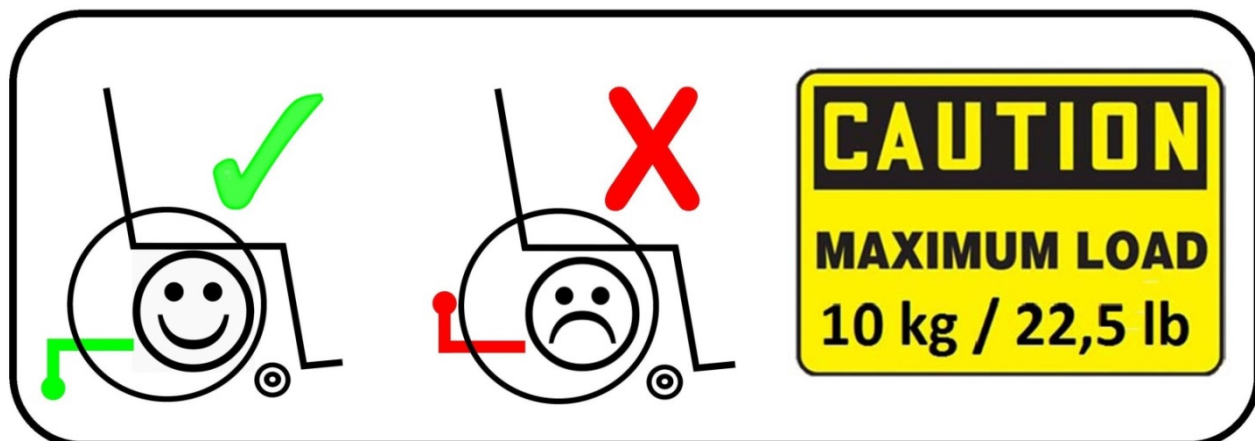

14. Instructions for use of a wheelchair together with the universal device rack:

1. The wheelchair must be equipped with: wheelbase extension, 2 reinforced wheels and seat tilt with 2 gas springs. The maximum load including user, accessories, universal device rack, and other equipment, must not exceed 160kg.
(not necessary for Netti V)
2. The anti-tips must always be swung downwards and locked to prevent the wheelchair tipping backwards and causing injury to bystanders or damage to property. There is an increased risk of tipping if nobody is sitting in the chair.
3. Do not push down on the anti-tips.
4. Avoid driving over kerbs or steps.

Make sure there are no kinks in any hoses , cables or other connections to the devices used on the rack. Make sure all devices in the rack on or the protective cover are properly secured to prevent them from moving and becoming damaged while the wheelchair is being used.

5. Make sure all devices and the connections to them are placed where they cannot collide with external obstacles while the chair is being moved.
6. Do not exceed the maximum load of 10 kg on the universal device rack.
7. Cleaning: the universal device rack may be cleaned using a mild detergent and a soft cloth . Do not use abrasive or aggressive cleaning materials.
8. Maintenance: regularly check that all the screws are tightened securely. If necessary contact your special dealer for advice.
9. **The wheelchair with Universal device carrier is not approved for being used as a seat in a vehicle.** Remove and secure the medical devices and the universal device carrier safely in the vehicle before using the wheelchair as a seat in a vehicle.
10. Disclaimer: Alu Rehab is not liable for any damage or injury resulting from improper use of this product.
11. Report any damage to the universal device rack or the wheelchair to your dealer or to Alu Rehab

Contact:

Alu Rehab AS | Bedriftsvegen 23 | 4353 Klepp stasjon | NORWAY
Alu Rehab ApS | Kløftehøj 8 | 8680 Ry | DENMARK

info.ry@meyragroup.com
www.my-netti.com