



Date _____

Customer code C- _____

Invoice address _____

Contact person _____

Reference _____

Other delivery address _____

Invoice address = delivery address

Quote

The chair will be used as seat for car transport.

Basic price: 4.250,- €

Excl. VAT

Seat width

D65055 550 mm

D65060 600 mm

Capacity

Max. 160 kg

Seat height

See page 7

Seat depth

425 – 500 mm adjustable
25 mm per step

D29488 Arm support comfort pads (reduces SW with 2 x 15 mm)

139,- €

D28002 Seat depth adjustment

59,- €

425 mm 450 mm 475 mm 500 mm

= Standard equipment

Quick order



only page 1 is send

Item nr.	Description	Price in €
Standard	<input checked="" type="checkbox"/> Head rest A, with side support	0,-
D27574	<input type="checkbox"/> Head rest B, small, oval	0,-
D27573	<input type="checkbox"/> Head rest C, large, square	0,-
D27572	<input type="checkbox"/> Head rest D, comfort (pressure distributive)	224,-
D82567	<input type="checkbox"/> Headrest A with side support and head band	323,-
D82568	<input type="checkbox"/> Extra comfort pads for the head band of D82567, pair	30,-
D22085	<input type="checkbox"/> Drum brakes (brake handles mounted on push bow)	229,-
D21063	<input type="checkbox"/> Universal tray for SW 550-600 mm	238,-
D21052	<input type="checkbox"/> Upholstery for tray	113,-
D20845	<input type="checkbox"/> Hip belt, with upholstery and car belt lock	107,-
D21022	<input type="checkbox"/> Easy Care cover (not available for Netti Sit °C)	0,-
D21076	<input type="checkbox"/> Configuration for car transportation for users higher than 185 cm incl.: D41006 Back extender 600 mm (only in combination with Netti	525,-

Smart/Stabil or Super Stabil cushion to receive a back cushion height 600 mm)
D21054 Vertical tube for headrest - 500 mm
D82025 Headrest adapter in aluminium

FRAME

Standard	<input checked="" type="checkbox"/>	Angle adjustable push bow	0,-
Standard	<input checked="" type="checkbox"/>	Anti tip, swingable	0,-
Standard	<input checked="" type="checkbox"/>	User brake	0,-
D86099	<input type="checkbox"/>	Brake lever extension +70 mm (length 200 mm) to be mounted by dealer	159,-
D28972	<input type="checkbox"/>	Anti tip with pedal, pair	186,-
D29474	<input type="checkbox"/>	Tilt-restrictor (no negative tilt frontwards)	41,-
D41074	<input type="checkbox"/>	Car fastening, pair	158,-
D28001	<input type="checkbox"/>	Frame extension including longer antitippers	275,-

BACK UNIT (for belts please see page 9)

Standard	<input checked="" type="checkbox"/>	Back cushion Netti Uno with 100 mm side support with 3D cover	0,-
Standard	<input checked="" type="checkbox"/>	Back height 500 mm (incl. adjustable velcro back)	0,-
D44993	<input type="checkbox"/>	Adjustable velcro with cut for side supports	273,-
D41006	<input type="checkbox"/>	Back extender 600 mm (only in combination with Netti Smart/Stabil or Super Stabil cushion to receive a back cushion height 600 mm)	222,-
D21338	<input type="checkbox"/>	Back cushion Netti Smart with 120 mm side support – 3D cover	306,-
D27374	<input type="checkbox"/>	Side support Correction with upholstery left - for Netti UNO and SMART	193,-
D27375	<input type="checkbox"/>	Side support Correction right with upholstery - for Netti UNO and SMART	193,-
D21333	<input type="checkbox"/>	Back cushion Netti Stabil – with 170 mm side support - 3D cover	497,-
D21334	<input type="checkbox"/>	Back cushion Netti Super Stabil – with 170 mm reinforced side support - 3D cover	579,-
	<input type="checkbox"/>	Ride Designs Back solution (See separate order form) Article number: _____ / Accessories: _____	
D26831	<input type="checkbox"/>	Side support Stable left - for Netti Stabil, Super Stabil & Kyphotic (please note: the armrests will then not be revolvable)	219,-
D26844	<input type="checkbox"/>	Side support Stable right - for Netti Stabil, Super Stabil & Kyphotic (please note: the armrests will then not be revolvable)	219,-
D27541	<input type="checkbox"/>	Side support upholstery Stable, pair	134,-
D27700	<input type="checkbox"/>	Firm back in aluminium, back height 500 mm	332,-
D27708	<input type="checkbox"/>	Firm back in aluminium, back height 600 mm (incl. D41006 back extender - only in combination with Netti Smart/Stabil or Super Stabil cushion to receive a back cushion height 600 mm)	554,-
D21084	<input type="checkbox"/>	Back wedge	164,-
D21042	<input type="checkbox"/>	Lumbar support	164,-

Libertas 15° back flexibility incl. long anti tips and frame extender
(Max. user weight 135 kg, not for transport in car)

Price on request

D82411 80N D82412 120N D82413 160N



Netti Dynamic FREE back cylinder

Price on request

Allows up to 40° trunk movements backwards. (Max. user weight 135 kg). The standard back recline can be locked in any position as the dynamic movement is blocked simultaneously, which can be appropriate during transport or positioning. Incl. frame extension D28001 and Bodypoint pelvic stabilizer 2-point belt.

For more information and choice of gas spring, feel free to contact us or have a look at our website. If combined with other options, please send us a request as some solution are only possible as special adaptations.

D82226 200N D82227 300N D82228 400N
 D82229 500N D82230 600N D82231 700N
 D82232 800N D82233 900N D82234 1000N
 D82235 1100N D82236 1200N D82237 1300N

SEAT UNIT (for belts please see page 8)

Standard	<input checked="" type="checkbox"/>	Seat cushion Netti Uno 3D cover	0,-
D21048	<input type="checkbox"/>	Netti Dry incontinence cover for seat cushion	212,-
D21007	<input type="checkbox"/>	Pressure relief seat cushion Netti Sit – 3D cover incl. incontinence layer	356,-
D21017	<input type="checkbox"/>	Pressure relief seat cushion Netti Sit °C with temperature regulating features and incontinence layer under the 3D cover	497,-
	<input type="checkbox"/>	Ride Designs Seat cushion (See separate order form) Article number: _____ / Accessories: _____	
D27493	<input type="checkbox"/>	Abduction block small (W: 80 mm x L: 140 mm x H: 80 mm)	235,-
D27494	<input type="checkbox"/>	Abduction block medium (W: 110 mm x L: 150 mm x H: 80 mm)	235,-
D27495	<input type="checkbox"/>	Abduction block large (W: 140 mm x L: 170 mm x H: 80 mm)	235,-

LEG SUPPORTS

For the Netti 4U CED XL you have 5 different types of leg supports with various accessories. Please contact us for consultation.

Manually angle adjustable leg supports

Standard	<input checked="" type="checkbox"/>	Manually angle adjustable leg supports with -automatic length adjustment -angle adjustable foot plates -calf supports and knee upholstery	0,-
D88211	<input type="checkbox"/>	Leg support upper parts with lever instead of star wheel for angle adjustment	80,-





		Bodypoint ankle huggers with upholstery	
<input type="checkbox"/>	D44863	S (L: 170-200 mm)	213,-
<input type="checkbox"/>	D44864	M (L: 190-230 mm)	213,-
<input type="checkbox"/>	D44865	L (L: 220-290 mm)	223,-
<input type="checkbox"/>	D44904	XL (L: 280-330 mm)	244,-

D80087	<input type="checkbox"/>	Depth adjustable hinge for footplates (50 mm in all) – mounted	444,-
D21008	<input type="checkbox"/>	Gas spring for angle adjustment	878,-
D21044	<input type="checkbox"/>	Foot board, adjustable	287,-
D21041	<input type="checkbox"/>	Foot box upholstered (not approved for car transport, if this is needed please use the Netti Grandis solution which is approved)	459,-
D21745	<input type="checkbox"/>	Calf support bracket upholstery - pair - skai cover	49,-
D41617	<input type="checkbox"/>	Calf support upholstery extra soft - pair - EC or 3D cover depending on the fabric for the whole chair	190,-
D28453	<input type="checkbox"/>	Foot plate upholstery - pair - skai cover	269,-
D86900	<input type="checkbox"/>	Bodypoint calf strap M	162,-
D86901	<input type="checkbox"/>	Bodypoint calf strap L	162,-

Universal leg supports

D24005	<input type="checkbox"/>	Universal leg supports with knee angle adjustment, adjustable below 90° for contract leg situations with seat unit tilted when chair is pushed	117,-
--------	--------------------------	---	-------



		Bodypoint ankle huggers with upholstery incl. mounting kit	
<input type="checkbox"/>	D44863	S (L: 170-200 mm)	213,-
<input type="checkbox"/>	D44864	M (L: 190-230 mm)	213,-
<input type="checkbox"/>	D44865	L (L: 220-290 mm)	223,-
<input type="checkbox"/>	D44904	XL (L: 280-330 mm)	244,-

D80087	<input type="checkbox"/>	Depth adjustable hinge for footplates (50 mm in all) – mounted	444,-
D21044	<input type="checkbox"/>	Foot board, adjustable	287,-
D21041	<input type="checkbox"/>	Foot box upholstered (not approved for car transport, if this is needed please use the Netti Grandis solution which is approved)	459,-
D86900	<input type="checkbox"/>	Bodypoint calf strap M	162,-
D86901	<input type="checkbox"/>	Bodypoint calf strap L	162,-

Netti Grandis angle adjustable leg supports

D88600	<input type="checkbox"/>	Netti Grandis angle adjustable positioning leg supports for complex individual configurations. Reduces pressure and shear forces. For users with e.g. contractions, leg asymmetry, elephantiasis.	987,-
--------	--------------------------	--	-------



The foot support is characterized by unique ergonomics and user-friendliness due to lifting handles, scale displays and conical extension pieces. Angle adjustable incl. angle limiter and adjustable calf- and foot supports.

D88602	<input type="checkbox"/>	Calf support upholstery extra soft - pair - EC or 3D cover depending on the fabric for the whole chair	190,-
--------	--------------------------	--	-------

D88607	<input type="checkbox"/>	Knee upholstery for the upper lower leg (3D or EC cover depending on the fabric for the whole chair)	102,-
D21745	<input type="checkbox"/>	Calf support bracket upholstery - pair - skai cover	49,-
D88604	<input type="checkbox"/>	Angle limiter (for limitation of angle upwards) – mounted	58,-
D88014	<input type="checkbox"/>	Foot fixation, pair incl. mounting kit	212,-
D88603	<input type="checkbox"/>	Foot board, lockable and upwards swingable	347,-
D88605	<input type="checkbox"/>	Footbox, upholstered with Skai cover (approved for car transport)	654,-
D21293	<input type="checkbox"/>	Calf strap	79,-
D86900	<input type="checkbox"/>	Bodypoint calf strap M	162,-
D86901	<input type="checkbox"/>	Bodypoint calf strap L	162,-

Netti Grandis amputation support



D88618	<input type="checkbox"/>	Amputation support left (amputation support on both sides only together with frame extension D28001) incl. Netti Grandis leg support right side	946,-
D88619	<input type="checkbox"/>	Amputation support right (amputation support on both sides only together with frame extension D28001) incl. Netti Grandis leg support left side	946,-

Netti Grandis leg support with fixed angle

D88612	<input type="checkbox"/>	Netti Grandis leg supports with fixed angle for complex individual configurations. Reduces pressure and shear forces. For users with e.g. contractions, leg asymmetry. The foot support is characterized by unique ergonomics and user-friendliness due to scale displays and conical extension pieces. Adjustable in a fixed angle – also below 90°. Including heel strap.	987,-
D88603	<input type="checkbox"/>	Foot board, lockable and upwards swingable	347,-
D88605	<input type="checkbox"/>	Footbox, upholstered with Skai cover (approved for car transport)	654,-



Netti Dynamic angle adjustable leg supports

		Netti Dynamic angle adjustable leg rests DUAL with calf supports and footboard, 100N.	Price on request
	D82296	<input type="checkbox"/>	Standard adjustment piece 300 mm (lower leg length 450-550 mm)
	D82298	<input type="checkbox"/>	Adjustment piece 214 mm (lower leg length 350-450 mm) Adjustable for different thigh lengths.
	D82318	<input type="checkbox"/>	Standard adjustment piece 300 mm (lower leg length 450-550 mm)
	D82319	<input type="checkbox"/>	Adjustment piece 214 mm (lower leg length 350-450 mm)
			
D45245	<input type="checkbox"/>	Reinforced automatic footboard lock - Not possible to combine with D82318/9 (extension bracket). With this lock the footboard is not angle adjustable, but this can be offered as special adaptation.	Price on request
D88211	<input type="checkbox"/>	Leg support upper parts with lever instead of star wheel for angle adjustment	80,-

	Bodypoint ankle huggers with upholstery		
<input type="checkbox"/>	D44863	S (L: 170-200 mm)	213,-
<input type="checkbox"/>	D44864	M (L: 190-230 mm)	213,-
<input type="checkbox"/>	D44865	L (L: 220-290 mm)	223,-
<input type="checkbox"/>	D44904	XL (L: 280-330 mm)	244,-
D21745	<input type="checkbox"/>	Calf support bracket upholstery - pair - skai cover	49,-
D41617	<input type="checkbox"/>	Calf support upholstery extra soft - pair - EC or 3D cover depending on the fabric for the whole chair	190,-
D86900	<input type="checkbox"/>	Bodypoint calf strap M	162,-
D86901	<input type="checkbox"/>	Bodypoint calf strap L	162,-

ARM REST AND ACCESSORIES FOR ARM REST

Standard	<input checked="" type="checkbox"/>	Arm rest height and depth adjustable, revolvable	0,-
Standard	<input checked="" type="checkbox"/>	Arm pads 385 x 58 mm	0,-
D41649	<input type="checkbox"/>	Arm pad upholstery extra soft, EC or 3D cover depending on the fabric for the whole chair (not to be combined with a tray)	99,-
D23003	<input type="checkbox"/>	Hemiplegic cushion	196,-
D29459	<input type="checkbox"/>	Arm support hemiplegic left (not to be combined with a tray)	296,-
D29460	<input type="checkbox"/>	Arm support hemiplegic right (not to be combined with a tray)	296,-



NEW:

Push rim controlled drive unit and easy propulsion with joystick or attendant control – order directly by Netti together with the requested comfort wheelchair. Please use separate order form

MAIN AND FRONT WHEELS

Standard	<input checked="" type="checkbox"/>	Main wheel 24 x 1" PU + front wheel 7" – 175 x 33 PU	0,-
D21021	<input type="checkbox"/>	Front wheels: 7" – 175 x 45 PU wheel - puncture proof - with PU infill (necessary for supportive engines)	79,-
D22007	<input type="checkbox"/>	Main wheel 22 x 1" PU + front wheel 6" 150 x 30 PU	132,-
D22011	<input type="checkbox"/>	Main wheels with suspension – Loopwheels Classic -24" pneumatic. Up to 70% less vibration. Cannot be combined with drum brakes. Max. capacity 120 kg (incl. chair und user)	1950,-
M70315	<input type="checkbox"/>	Main wheels 12½" PU with drum brakes – frame brakes are delivered with the chair but are not compatible with the 12" wheels. Please contact us for an offer of a frame brake option. (Please note! These wheels are delivered in an extra box and are to be mounted by the dealer)	345,-
M70316	<input type="checkbox"/>	Main wheels 16" PU with drum brakes – frame brakes are delivered with the chair but are not compatible with the 16" wheels. Please	345,-

contact us for an offer of a frame brake option.
(Please note! These wheels are delivered in an extra box and are to be mounted by the dealer)

D22009	<input type="checkbox"/>	Hand and spoke protector – transparent, pair	138,-
D22013	<input type="checkbox"/>	Push rim cover, pair	112,-

HEAD SUPPORT AND ACCESSORIES FOR HEAD SUPPORTS (Please also see page 1)

D82025	<input type="checkbox"/>	Head support adapter aluminium	224,-
D82746	<input type="checkbox"/>	Netti Dynamic head support C incl. head support adapter in aluminium. If combined with other options, please send us a request, as some solutions are only possible as special adaptations. For more information, feel free to contact us.	Price on request
D27577	<input type="checkbox"/>	Head support E with adjustable side supports	290,-
D27581	<input type="checkbox"/>	Headrest E with shorter side support right	370,-
D27582	<input type="checkbox"/>	Headrest E with shorter side support left	370,-
D27578	<input type="checkbox"/>	Head support F with cheek support	290,-
D21027	<input type="checkbox"/>	Headrest adjustment tube (horizontal) + 100 mm, length 250 mm	79,-
D21028	<input type="checkbox"/>	Headrest adjustment tube (horizontal) + 230 mm, length 380 mm	89,-
D21054	<input type="checkbox"/>	Headrest adjustment tube (vertical) + 100 mm, length 500 mm	79,-
D23004	<input type="checkbox"/>	Comfort cushion for head rest type C – removable with Mars cover	162,-
D23012	<input type="checkbox"/>	Easy Care cover for head rest type A, B, C – removable	79,-
D23013	<input type="checkbox"/>	3D cover for head rest type A, B, C – removable	79,-
D23015	<input type="checkbox"/>	Grey head rest cushion with Mars cover	214,-



D45370	<input type="checkbox"/>	[A] Savant head support incl. headband, small – height 130 mm User forehead 460-560 mm User ½ circumference behind ears 150-180 mm Inside distance along top support 300 mm, along middle support 180 mm (not approved for car transport – if this is needed please order an additional Netti headrest)	Price on request
D45371	<input type="checkbox"/>	[A] Savant head support incl. headband, adult – height 150 mm User forehead 560-610 mm User ½ circumference behind ears 200-300 mm Inside distance along top support 360 mm, along middle support 200 mm (not approved for car transport – if this is needed please order an additional Netti headrest)	Price on request
D45373	<input type="checkbox"/>	[B] Side pads for Savant head support. For extra lateral support. For the upper arms of the head support. Cannot be combined with the headband	Price on request
D45375	<input type="checkbox"/>	Headrest adjustment tube (horizontal) +100 mm, length 250 mm	Price on request
D45368	<input type="checkbox"/>	[C] Axion head support rotary interface, permits a lateral rotation of 60°.	Price on request

		Only for Savant headrest. (not approved for car transport – if this is needed please order an additional Netti headrest)	
D45376	<input type="checkbox"/>	Axion head support rotary interface, permits a lateral rotation of 90°. Only for Savant headrest. (not approved for car transport – if this is needed please order an additional Netti headrest)	Price on request
D89558	<input type="checkbox"/>	[C] Axion head support rotary interface, permits a lateral rotation of 60°. Only for Netti headrest. (not approved for car transport – if this is needed please order an additional standard Netti headrest)	Price on request
D89559	<input type="checkbox"/>	Axion head support rotary interface, permits a lateral rotation of 90°. Only for Netti headrest. (not approved for car transport – if this is needed please order an additional standard Netti headrest)	Price on request

VARIOUS ACCESSORIES

D21087	<input type="checkbox"/>	Clinic-kit (tools) for angle adjustable foot supports	106,-
D21239	<input type="checkbox"/>	Tool kit	89,-
D42269	<input type="checkbox"/>	Wheelchair bag	140,-
D80085	<input type="checkbox"/>	Universal device basket incl. frame extension D28001 SW 450: W: 405 mm, D: 305, H: 70 mm (for other seat widths please subtract or add from SW 450 mm) Max. capacity 6 kg For information concerning car transport, please see the user manual of the device basket on our website.	Price on request
			
D41987	<input type="checkbox"/>	Intravenous rack	298,-

BELT OPTIONS FROM BODYPOINT AND NETTI

Belts and accessories for seat unit



[A]



[B]



[C]







[D]

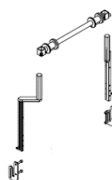

[E]

D86282	<input type="checkbox"/>	Belt bracket kit – seat [A]	98,-
D20845	<input type="checkbox"/>	Hip belt, with upholstery and car belt lock [B]	107,-
D45276	<input type="checkbox"/>	Bodypoint 2-point pelvic stabiliser for SW 550-650 mm (overall pad length: 820 mm) incl. mounting kit [A+C]	252,-
D60001	<input type="checkbox"/>	Abduction belt [D]	497,-
		Bodypoint supportive universal elastic strap [E]	170,-
D45084	<input type="checkbox"/>	S (Height 80 mm - 1420 mm long, easily cut-to-length)	
D45085	<input type="checkbox"/>	L (Height 110 mm - 1420 mm long, easily cut-to-length)	
D45086	<input type="checkbox"/>	XL (Height 150 mm - 1420 mm long, easily cut-to-length)	



Belts and accessories for back unit

				
[A]	[B]	[C]	[D]	[E]
D86890	<input type="checkbox"/>	H-harness adaptor kit (recommended for all upper body harnesses)		250,-
D20881	<input type="checkbox"/>	H-belt, with upholstery and car belt lock [B]		227,-
D41645	<input type="checkbox"/>	Belt cross harness [C]		175,-
		Bodypoint Stayflex chest support without zipper [D]		246,-
D86895	<input type="checkbox"/>	M (Shoulder width 330-410 mm)		
D86896	<input type="checkbox"/>	L (Shoulder width 410-480 mm)		
		Bodypoint Pivofit shoulder harness [E]		246,-
D86898	<input type="checkbox"/>	M (Shoulder width 330-410 mm)		
D86899	<input type="checkbox"/>	L (Shoulder width 410-480 mm)		

NETTI CUSTOMIZED

Netti has many years of experience in developing customized solutions. Feel free to contact us for a quote concerning your individual solution.

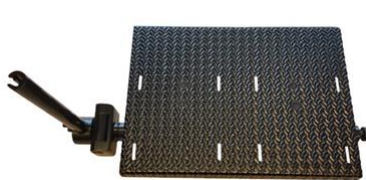
CUSTOM MADE – most wanted special adapted items (price on request)

		
A	B	C
<input type="checkbox"/>	Reinforced foot board in aluminium (A)	
<input type="checkbox"/>	Extra-long calf supports (please state length) (B)	
<input type="checkbox"/>	Calf support upholstery in special length or material	
<input type="checkbox"/>	Back cushion with special side support (C)	
<input type="checkbox"/>	Footboard that swings horizontally forwards	
<input type="checkbox"/>	Sliding seat (for positioning and transfer)	
<input type="checkbox"/>	Comfort seat plate	
<input type="checkbox"/>	One hand brake (please state which side)	

Please describe your current case and how a possible solution could look. If you have any picture or video material, we would also like to see this. To offer the best solution, please describe the user in the best possible way, e.g. such as any given diagnosis, user weight and/or the exact pattern movement of the user.

User weight:

Please write the exact measurements and draw the wished solution for the requested accessories e.g. by using the drawings underneath.

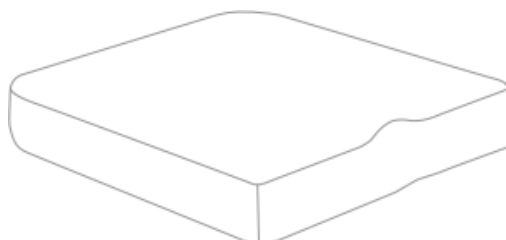
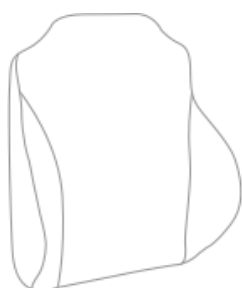

Please inform us if there are any special circumstances in the living area that has an influence for the chair: e.g. the total possible width _____ mm and length _____ mm of the chair.

TECHNICAL DATA

Tilt (seat)	-5° to +20°
Recline (back)	92° to 137°
Total width of the wheelchair	Seatwidth + 180 mm (std. wheels)/ + 195 mm (DB wheels) / +170 mm (12" + 16" DB wheels)
Total length	1020 mm with leg rests
Total height	1050 mm
Distance arm support to seatplate	Min. 265 mm / max. 355 mm
Weight of wheelchair	App. 30 kg (without cushion)
Frame colour	Grey
Cover variants	3D Cover (optional Easy Care cover with D21022)
Crash test	ISO 7176-19 (136 kg)

Seat height – WITHOUT seat cushion (measured from floor to seat plate)

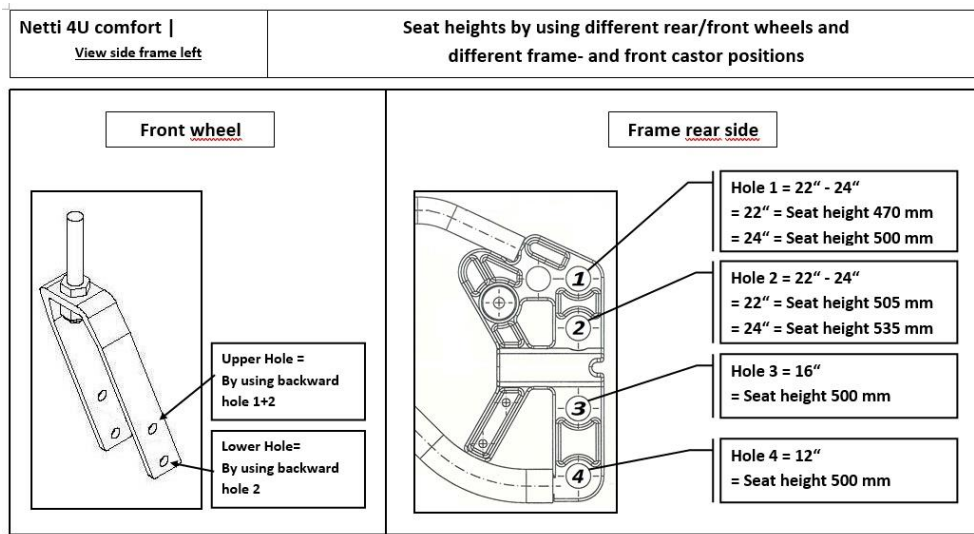

With wheel combination 22" + 6" the seat height 440 and 475 mm is possible.

Leg rest type	Min. calf length	Max. calf length
Manual adjustable leg rests	320 mm	680 mm
Universal leg rests	360 mm	500 mm
Netti Grandis leg rests	360 mm	640 mm
Netti Grandis fixed leg rests	380 mm	550 mm

