

Date _____
 Invoice address _____

Customer code C- _____
 Contact person _____
 Reference _____
 Other delivery address _____

Invoice address = delivery address

Quote



The Java Back's patented biomechanical design provides the flexibility to easily and independently optimize pelvic support and balance the trunk for excellent support, comfort and mobility.

- 3 back heights (360, 460, 560 mm)
- 2 depths (80, 150 mm)



Target group:

- Low to medium postural asymmetry
- Substantial need for help with balancing the trunk, support required

Delivery time for Ride Designs products is 4-15 workdays.

		Article number	Price in €
<input checked="" type="checkbox"/>	Mounting hardware for round back tubes (diameter 19-25.4 mm)		Included
<input type="checkbox"/>	Mounting hardware for square back tubes (e.g. Netti III, Netti 4U CED, Netti 4U CE Plus). Included if the back is ordered together with a Netti wheelchair.	2 x 89509	128,-
<input type="checkbox"/>	Extra outer cover Specify width and height if ordered separately W: _____ H: _____	CJB-	210,-

NORWAY: Alu Rehab AS | Bedriftsvegen 23 | N-4353 Klepp stasjon | post@My-Netti.com | Phone +47 51 78 62 20
 DENMARK: Alu Rehab ApS | Kløftehøj 8 | DK-8680 Ry | info@My-Netti.com | Phone +45 87887300

Ride® Java® Back Regular

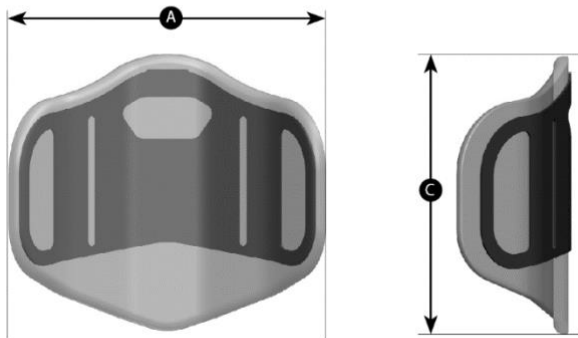

How to find the correct back width?

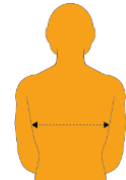

We recommend:
Width inside foam = Chest width + 50-80 mm depending on the user

	B: Width inside foam	Fits wheelchair widths	A: Overall back width	C: Back height	Article number	Price in €
HEIGHT: REGULAR 360 mm – DEPTH: REGULAR (80 mm)						
<input type="checkbox"/>	330 mm	350-430 mm	360 mm	360 mm	JB-1414	895,-
<input type="checkbox"/>	340 mm	380-450 mm	380 mm	360 mm	JB-1514	895,-
<input type="checkbox"/>	370 mm	400-450 mm	410 mm	360 mm	JB-1614	895,-
<input type="checkbox"/>	390 mm	430-500 mm	430 mm	360 mm	JB-1714	895,-
<input type="checkbox"/>	420 mm	450-500mm	460 mm	360 mm	JB-1814	895,-
<input type="checkbox"/>	440 mm	500-550 mm	480 mm	360 mm	JB-1914	895,-
<input type="checkbox"/>	470 mm	500-550 mm	510 mm	360 mm	JB-2014	895,-
HEIGHT: REGULAR 360 mm – DEPTH: DEEP (150 mm)						
<input type="checkbox"/>	330 mm	350-430 mm	360 mm	360 mm	JB-1414DP	945,-
<input type="checkbox"/>	340 mm	380-450 mm	380 mm	360 mm	JB-1514DP	945,-
<input type="checkbox"/>	370 mm	400-450 mm	410 mm	360 mm	JB-1614DP	945,-
<input type="checkbox"/>	390 mm	430-500 mm	430 mm	360 mm	JB-1714DP	945,-
<input type="checkbox"/>	420 mm	450-500mm	460 mm	360 mm	JB-1814DP	945,-
<input type="checkbox"/>	440 mm	500-550 mm	480 mm	360 mm	JB-1914DP	945,-
<input type="checkbox"/>	470 mm	500-550 mm	510 mm	360 mm	JB-2014DP	945,-

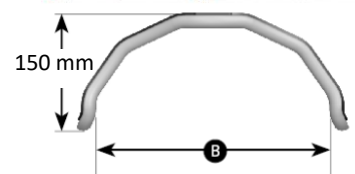
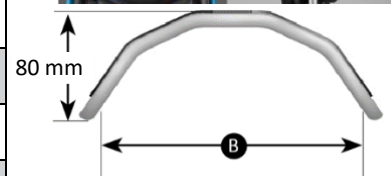

Ride® Java® Back Tall

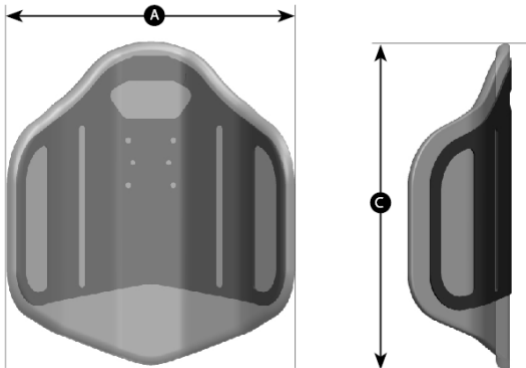

How to find the correct back width?

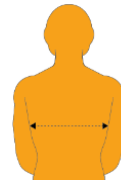

We recommend:
Width inside foam = Chest width + 50-80 mm depending on the user

	B: Width inside foam	Fits wheelchair widths	A: Overall back width	C: Back height	Article number	Price in €
HEIGHT: TALL – DEPTH: REGULAR (80 mm)						
<input type="checkbox"/>	330 mm	350-430 mm	360 mm	460 mm	JB-1418	895,-
<input type="checkbox"/>	340 mm	380-450 mm	380 mm	460 mm	JB-1518	895,-
<input type="checkbox"/>	370 mm	400-450 mm	410 mm	460 mm	JB-1618	895,-
<input type="checkbox"/>	390 mm	430-500 mm	430 mm	460 mm	JB-1718	895,-
<input type="checkbox"/>	420 mm	450-500 mm	460 mm	460 mm	JB-1818	895,-
<input type="checkbox"/>	440 mm	500-550 mm	480 mm	460 mm	JB-1918	895,-
<input type="checkbox"/>	470 mm	500-550 mm	510 mm	460 mm	JB-2018	895,-
HEIGHT: TALL – DEPTH: DEEP (150 mm)						
<input type="checkbox"/>	330 mm	350-430 mm	360 mm	460 mm	JB-1418DP	945,-
<input type="checkbox"/>	340 mm	380-450 mm	380 mm	460 mm	JB-1518DP	945,-
<input type="checkbox"/>	370 mm	400-450 mm	410 mm	460 mm	JB-1618DP	945,-
<input type="checkbox"/>	390 mm	430-500 mm	430 mm	460 mm	JB-1718DP	945,-
<input type="checkbox"/>	420 mm	450-500 mm	460 mm	460 mm	JB-1818DP	945,-
<input type="checkbox"/>	440 mm	500-550 mm	480 mm	460 mm	JB-1918DP	945,-
<input type="checkbox"/>	470 mm	500-550 mm	510 mm	460 mm	JB-2018DP	945,-

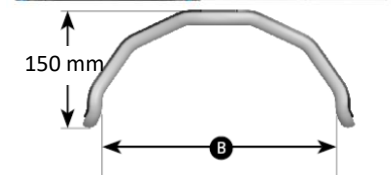
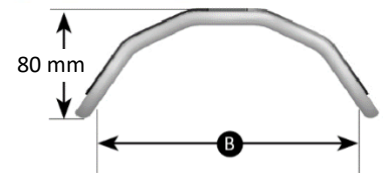

Ride® Java® Back Grande

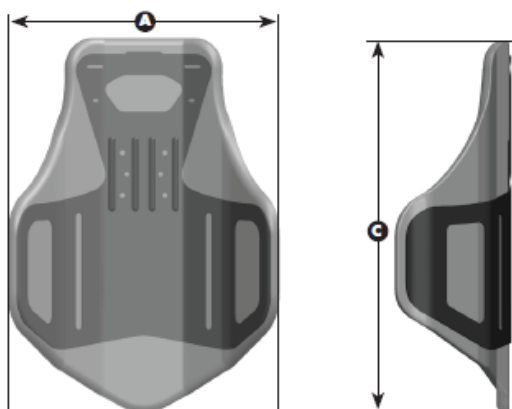

How to find the correct back width?

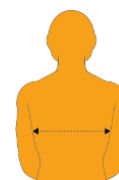

We recommend:
Width inside foam = Chest width + 50-80 mm depending on the user

	B: Width inside foam	Fits wheelchair widths	A: Overall back width	C: Back height	Article number	Price in €
HEIGHT: GRANDE – DEPTH: REGULAR (80 mm)						
<input type="checkbox"/>	330 mm	350-430 mm	360 mm	560 mm	JB-1422	895,-
<input type="checkbox"/>	340 mm	380-450 mm	380 mm	560 mm	JB-1522	895,-
<input type="checkbox"/>	370 mm	400-450 mm	410 mm	560 mm	JB-1622	895,-
<input type="checkbox"/>	390 mm	430-500 mm	430 mm	560 mm	JB-1722	895,-
<input type="checkbox"/>	420 mm	450-500 mm	460 mm	560 mm	JB-1822	895,-
<input type="checkbox"/>	440 mm	500-550 mm	480 mm	560 mm	JB-1922	895,-
<input type="checkbox"/>	470 mm	500-550 mm	510 mm	560 mm	JB-2022	895,-
HEIGHT: GRANDE – DEPTH: DEEP (150 mm)						
<input type="checkbox"/>	330 mm	350-430 mm	360 mm	560 mm	JB-1422DP	985,-
<input type="checkbox"/>	340 mm	380-450 mm	380 mm	560 mm	JB-1522DP	985,-
<input type="checkbox"/>	370 mm	400-450 mm	410 mm	560 mm	JB-1622DP	985,-
<input type="checkbox"/>	390 mm	430-500 mm	430 mm	560 mm	JB-1722DP	985,-
<input type="checkbox"/>	420 mm	450-500 mm	460 mm	560 mm	JB-1822DP	985,-
<input type="checkbox"/>	440 mm	500-550 mm	480 mm	560 mm	JB-1922DP	985,-
<input type="checkbox"/>	470 mm	500-550 mm	510 mm	560 mm	JB-2022DP	985,-

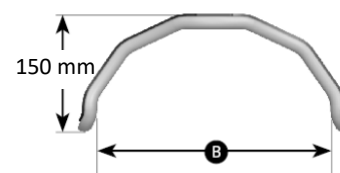
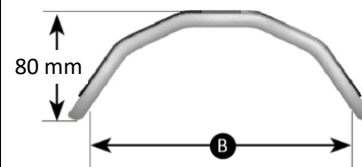
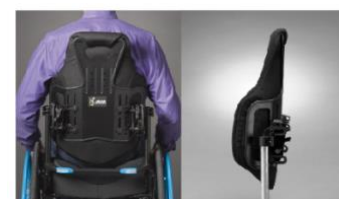

Lateral trunk support for Ride® Java® Back

For back depth 80 mm only

		Article number	Price in €/ piece
<input type="checkbox"/>	Fixed	JB-L007 – JB-L018	295,-
<input type="checkbox"/>	Swing away	JB-L031 – JB-L054	475,-
Size	<input type="checkbox"/> Small – H: 30 mm, W: 125 mm <input type="checkbox"/> Medium – H: 40 mm, W: 150 mm <input type="checkbox"/> Large – H: 50 mm, W: 150 mm		
Shape	<input type="checkbox"/> Flat <input type="checkbox"/> Curved		
Side	<input type="checkbox"/> Right <input type="checkbox"/> Left		

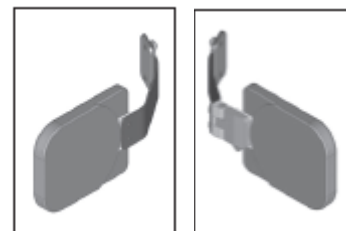

Fixed

Swing-away

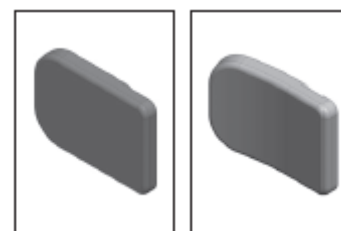

Flat

Curved

Accessories

		Article number	Price in €
<input type="checkbox"/>	Additional pelvic wedges (pair) Ensure extra rear side pelvic support	JB-PW	55,-
<input type="checkbox"/>	Additional Flexa-Just stays – thin aluminium strips (pair)	JB-FAS	55,-
<input type="checkbox"/>	Ride Privacy flap		
<input type="checkbox"/>	Small (back width 360 mm)	JB-PFS	40,-
<input type="checkbox"/>	Medium (back width 380-430)	JB-PFM	40,-
<input type="checkbox"/>	Large (back width 460-510)	JB-PFL	40,-
<input type="checkbox"/>	Quickie® fold-down push handle adapter	6000-391	45,-

Head rest mounting directly on Ride® Java® Back

Can be mounted directly on the Java Back.

Please order the required Netti headrest separately.

	Please note: Only compatible with Java Back Tall and Grande.	Article number	Price in €
<input type="checkbox"/>	Head support adapter Netti standard incl. mounting material for mounting directly to the Java back	91474	90,-
<input type="checkbox"/>	Head support adapter Netti aluminium incl. mounting material for mounting directly to the Java back	91477	247,-
<input type="checkbox"/>	Additional price in connection with chair orders (in addition to the standard adapter or in addition to the price of the aluminium adapter D82025 if this has been ordered).	D20555	59,-
<input type="checkbox"/>	Symmetric Design Apex headrest hardware system for symmetrical and asymmetrical head positions.	46403	197,-
<input type="checkbox"/>	Apex headrest oval 200x115 mm (Please note: 46403 is required)	45423	172,-
<input type="checkbox"/>	Apex headrest with wings 230x140 mm (Please note: 46403 is required)	45424	222,-
<input type="checkbox"/>	Netti headrest adapter (for mounting of Netti headrests on Apex headrest hardware system)	89558	152,-
	Savant head rest incl. headband, small – height 130 mm. User forehead 460-560 mm. ½ user circumference behind ears 150-180 mm. Inside distance along top support 300 mm, along middle support 180 mm. Please note: 46403 is required	45366	585,-
<input type="checkbox"/>	Savant head rest incl. headband, adult – height 150 mm. User forehead 560-610 mm. ½ user circumference behind ears 200-300 mm. Inside distance along top support 360 mm, along middle support 200 mm. Please note: 46403 is required	45367	585,-

