



# E-Drive PLUS

## User manual



2018-03





## EC Declaration of Conformity

The undersigned, representing the following manufacturer:

Decon Wheel AB  
Org.no. 556618-9006  
Södra Ekeryd 119, 314 93 HYLTEBRUK  
SWEDEN

hereby declares that the product

**E-Drive part No. series:**

MED216	MEDL216
MED220	MEDL220
MED222	MEDL222
MED224	MEDL224
MED225	MEDL225
MED226	MEDL226

is in conformity with the provision of the following EC directive, including all applicable amendments:

93/42 EEC Medical Device Directive – Class 1 – annex VII

The manufacturer is exclusively responsible for this EC Declaration of Conformity.

This declaration is valid until June 30, 2021



Benny Andersson  
COO



# Important Information

## Responsibility

Decon cannot be held responsible for product changes made by unauthorized people.

As a part of an ongoing product improvement initiative, Decon reserves the right to change specifications and design without notice.

## Label location



CE Marks are placed on the motor, on the battery label on the battery, and on the label on the battery charger, which even is marked with the registration number including the production year and month.



# Table of Contents

<b>1. Please Read Before Use</b>	<b>1</b>
1.1. Foreword	1
1.2. Symbols Used in This Manual	1
1.3. Operation Diagnosis Check	2
1.4. Assistive Operation Diagnosis Check	3
1.5. Warnings and Notes for the Operation	4
1.6. Warning Label Location Diagram	26
<b>2. Names of Parts</b>	<b>27</b>
2.1. E-Drive PLUS 24"	27
2.2. E-Drive PLUS 16"	28
2.3. Controller	29
2.4. Assistant Controller (Optional)	29
2.5. Nickel Metal Hydride Battery (JWB2)	30
2.6. Nickel Metal Hydride Battery Charger (JWC-2)	31
2.7. Lithium Ion Battery (ESB1)	32
2.8. Lithium Ion Battery Charger (ESC1)	33
<b>3. Before Sitting in the Wheelchair</b>	<b>34</b>
3.1. Inspecting the Wheelchair	34
3.2. Checking Your Clothing	37
3.3. Checking the Residual Capacity of the Battery and Installing the Battery on the Wheelchair	38
<b>4. Riding the Wheelchair</b>	<b>40</b>
4.1. Sitting in the Wheelchair	40
4.2. Moving the Wheelchair	42
4.3. Adjusting and Confirming the Maximum Speed	44
4.4. Checking the Residual Capacity of the Battery during Operation	45
4.5. Other Functions	46
4.6. Practicing Basic Operations	47

<b>5. After You are Finished Riding the Wheelchair</b>	<b>49</b>
5.1. Getting Out of the Wheelchair	49
5.2. Removing the Battery	50
<b>6. How to Use the Assistant Controller</b>	<b>51</b>
6.1. Getting in the Wheelchair	51
6.2. Starting Assistant Travel Mode	51
6.3. After Assistant Operations are Finished	54
<b>7. Handling the Batteries and Chargers</b>	<b>55</b>
7.1. Types of Batteries	55
<b>8. Nickel Metal Hydride Battery and Charger</b>	<b>59</b>
8.1. Features of the Nickel Metal Hydride Battery (JWB2)	59
8.2. How to Use the Nickel Metal Hydride Battery (JWB2)	59
8.3. Characteristics and Handling of the Nickel Metal Hydride Battery (JWB2)	61
8.4. How to Charge the Nickel Metal Hydride Battery (JWB2)	63
8.5. Refresh Charging the Nickel Metal Hydride Battery (JWB2)	66
8.6. Charger (JWC-2) Indicator Lamps	68
<b>9. Lithium Ion Battery and Charger</b>	<b>69</b>
9.1. Features of the Lithium Ion Battery (ESB1)	69
9.2. How to Use the Lithium Ion Battery (ESB1)	69
9.3. Characteristics and Handling of the Lithium Ion Battery (ESB1)	71
9.4. How to Charge the Lithium Ion Battery (ESB1)	74
9.5. The Temperature of the Lithium Ion Battery (ESB1) during Charging	77
9.6. Charge Lamp Indication	78

<b>10. Wheelchair Transporting and Storing Instructions</b>	<b>79</b>
10.1. Loading the Wheelchair in a Car	79
10.2. Unloading the Wheelchair from a Car	81
10.3. Storing the Wheelchair	82
10.4. Boarding an Airplane	83
10.5. Long-term Storing the Wheelchair (longer than 3 Months)	83
<b>11. Using the Wheelchair more Comfortably</b>	<b>84</b>
11.1. Removing and Installing the Unit	84
11.2. Anti-tip Device	87
11.3. Controller	89
11.4. Assistant Controller (Optional)	93
11.5. Clutch Levers	93
11.6. Parameter Settings	93
11.7. Smart Tune Settings	95
<b>12. Maintenance, Daily Check, Periodic Inspection</b>	<b>97</b>
12.1. Maintenance	98
12.2. Daily Checks	100
12.3. Quit to Use E-Drive PLUS and Recycling	100
<b>13. Dimensions and Specifications</b>	<b>101</b>
<b>14. Troubleshooting</b>	<b>103</b>
14.1. Before Requesting Repairs	103
14.2. Requesting Repairs and Inspections	107
14.3. Serial Number Location	107
14.4. Warranty	107
14.5. Product Safety Notice and Product Recall Information	107

## Introduction

This is a manual for the E-Drive PLUS electric power unit for wheelchairs. Before you read this manual, check which product you are using.

This product consists of the left and right drive units, the joystick-equipped controller, the battery, optional battery bag, the battery charger, and the optional assistant controller. These components, except for the battery and charger, are already installed to the wheelchair frame. For the initial use, the customer does not have to use tools, and so on, to assemble the wheelchair. Refer to “2. Names of Parts” to ensure that these components are installed to the wheelchair that you purchased and that the battery and charger are included. If you visually notice that any of these components are not installed, are not included, or are damaged before using the wheelchair, immediately contact the dealer without using the wheelchair.

### E-Drive PLUS 24"

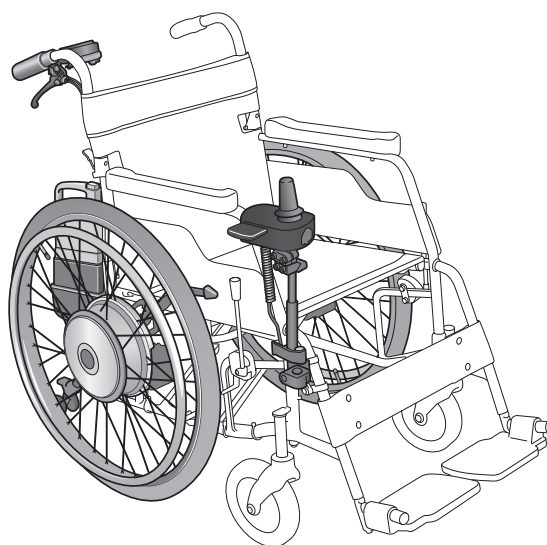

### E-Drive PLUS 16"

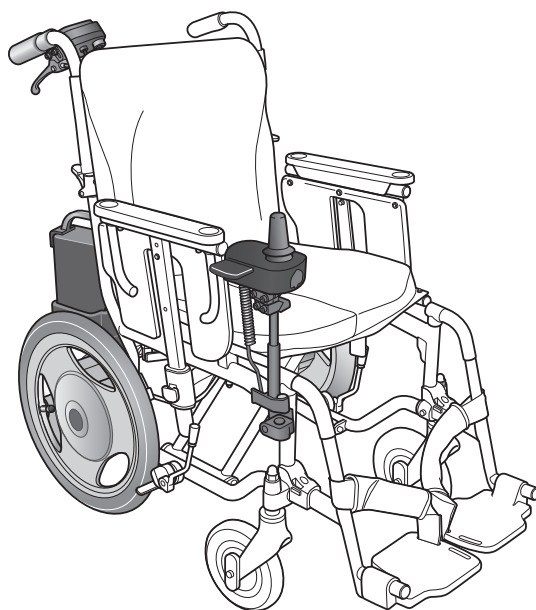

For information for operating the wheelchair frame and warranty for the frame with which you are using the E-Drive PLUS, see the frame manual.

# 1. Please Read Before Use

Caution: Federal law restricts this device to sale by or on the order of a practitioner licensed by the law of the State in which he/she practices.

## 1.1. Foreword



Thank you for purchasing the E-Drive PLUS.

Indication for use: The device E-Drive PLUS is a Power Assist Wheelchair Conversion Kit and suitable for the manual wheelchair users who are limited in their field of activities because of their physical conditions. The device can expand their field of activities by assisting their wheelchair operating force. The device is intended for indoor and outside use. Generally speaking, riding in a wheelchair incurs the possible risk of personal injury or damage to the wheelchair from improper use. Depending on the type or extent of the disabilities of the user, it might be dangerous to travel unaccompanied.

Before using the wheelchair, be sure that not only the user, but also the assistant and controller, has read this manual to assure full understanding.

- (1) The wheelchairs on which the E-Drive PLUS has been installed are wheelchairs for physically handicapped people, and their legal status is that of a pedestrian. Make sure to adhere to the traffic rules and manners of a pedestrian.
- (2) The E-Drive PLUS 24" withstands a load of 125 kg. Use with a total maximum load including the chairframe weight of 125 kg. The E-Drive PLUS 16" withstands a load of 100 kg. Use with a maximum load of 100 kg. If the frame on which the E-Drive PLUS is installed has an even lighter load capacity, ensure that you do not exceed that value.
- (3) To ensure safe use, warning labels are affixed to this product. Make sure to adhere to the warning labels. Refer to "Warning Label Location Diagram" for the locations of the warning labels.
- (4) Do not use this product for any purpose other than as an electric wheelchair.
- (5) Some of the illustrations in this manual are images of general electric wheelchairs. The actual product may be different than that shown.
- (6) E-Drive PLUS is replacing your wheelchairs original wheels. Please check your wheelchairs manual for changing any settings to the wheelchair. Be aware that some adjustments can influence the wheelchairs stability. Please always use the anti-tip devices.

## 1.2. Symbols Used in This Manual

	Indicates safety-related cautionary information.
 <b>WARNING</b>	Indicates that misuse may lead to fatal or severe injury, or disability.
<i>NOTICE</i>	Indicates that misuse may lead to material damage.
	Indicates things you must not do.
<b>TIP</b>	Indicates correct methods and key points when operating the product.

# 1.3. Operation Diagnosis Check

Depending on the extent of your disabilities, it may be dangerous to travel unaccompanied. Use this diagnosis check as a guide to determine whether or not you can travel unaccompanied.

## Diagnosis Check 1

(1) Are you able to move the joystick and switches on the controller at your own will?

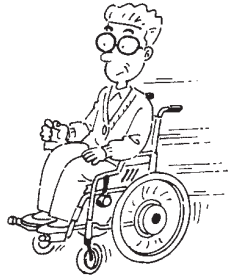

(2) Are you able to correctly perceive visually the conditions of the road surface and your surroundings, and avoid dangerous areas?



Can operate both.

Have trouble operating one or both.

Use this product by having an assistant provide assistive operation.



## Diagnosis Check 2

(1) Are you able to operate the parking brakes and clutch levers?



(2) Are you able to get in and out of the wheelchair, and to replace the battery?

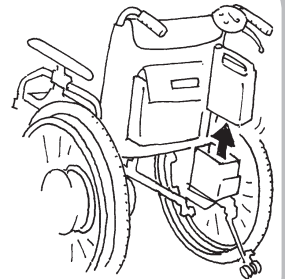

Can operate both.

Have trouble operating one or both.

Have an assistant accompany you.



You can travel unaccompanied. For your safety, remember to travel carefully. In situations such as those mentioned in the warnings in “Warnings and Notes for the Operation”, be sure to have an assistant accompany you, and pay sufficient attention to safety while traveling.

## WARNING

Before using the wheelchair, be sure to assess your competence and determine whether or not you need an assistant.

Moreover, in determining the necessity of an assistant, consult expert opinions as a point of reference.

If your judgment is based solely on your own opinion, you or other people around you may get injured.



## 1.4. Assistive Operation Diagnosis Check

Use the diagnosis check below as a guide to determine whether or not you can provide assistive operation.

### Diagnosis Check

If you feel uncomfortable with any of the 3 tasks below, do not provide assistive operation.

- (1) Are you able to correctly perceive the conditions of the road surface and your surroundings, and avoid dangerous areas?



- (2) Are you able to assist the user to get on and off the wheelchair, and to replace the battery?

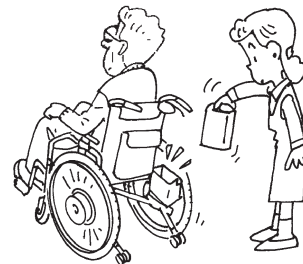

- (3) Are you able to provide assistive operation on a manual wheelchair?





**! WARNING**

If an assistant is to accompany you and operate the wheelchair, be sure to assess his or her competence. Moreover, when assessing the assistant's competence, consult expert opinions as a point of reference. If your judgment is based solely on your own opinion, you or other people around you may get injured.

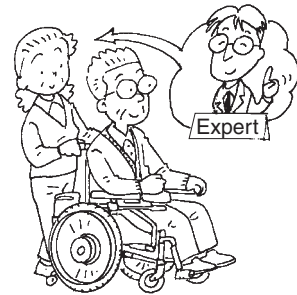

If you lack the competence to provide assistive operation, do not attempt to provide it.



### 1.5. Warnings and Notes for the Operation

Please read this manual before using the product.

Please read this manual carefully to ensure safe and comfortable operation. After reading it, store it where it can be accessed easily for future reference.

Unless specifically noted, the following information applies to when the user is operating the wheelchair themselves and when an assistant is operating the wheelchair using the assistant operations.

#### 1.5.1. Before Using the Wheelchair After Purchasing the Unit

**! WARNING**

Before using the wheelchair, be sure to assess your competence and determine whether or not you need an assistant. Moreover, in determining the necessity of an assistant, consult expert opinions as a point of reference. If your judgment is based solely on your own opinion, you or other people around you may get injured.

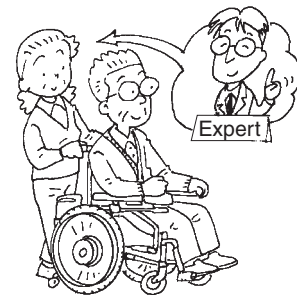

Practice traveling on a level and safe area with an assistant accompanying you, until you are comfortable with the operation. If you go on public roads while still unfamiliar with the operation, you or other people around you may get injured.



### 1.5.2. Before Use Every Day

#### WARNING

Perform the daily checks before use every day. Make a habit out of inspecting the wheelchair. Continued use of the wheelchair with a problem in the wheelchair body or the wheels may cause damage to the wheelchair while traveling, and may result in a rollover or fall.

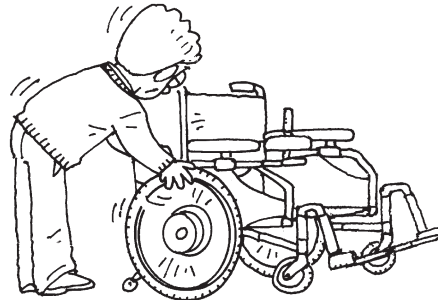

Before using the wheelchair every day, ensure that there is air in the tires. Always keep the air pressure in the rear tires at a normal level. If the air pressure in the rear tires decreases, the parking brakes may become ineffective.

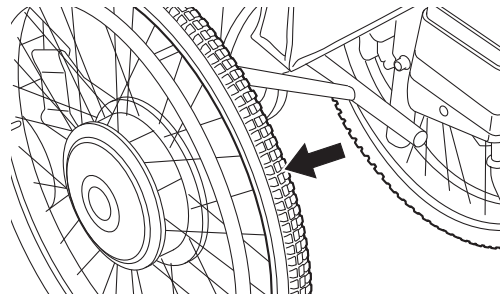

Before using the wheelchair every day, ensure that the anti-tip device is in the correct position. If the anti-tip device is not in the correct position, the wheelchair could fall backward.



Before using the wheelchair every day, check the residual capacity of the battery. If the residual capacity of the battery is low, the battery may run out during operation and it may become impossible to travel in power drive mode.

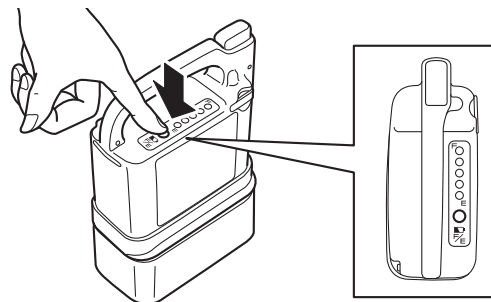

### 1.5.3. Handling the Wheelchair

#### WARNING

Modifying the unit or its mounting may adversely affect its performance and safety. Never make any modifications.

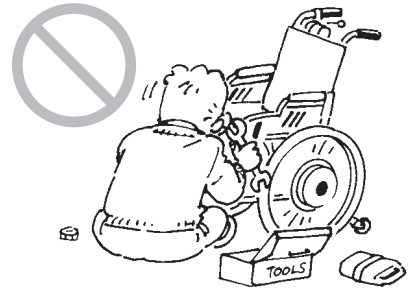

If the wheelchair has parts that are foldable or detachable, do not operate the wheelchair with those parts folded or removed.

When lifting the wheelchair, do not hold movable parts.

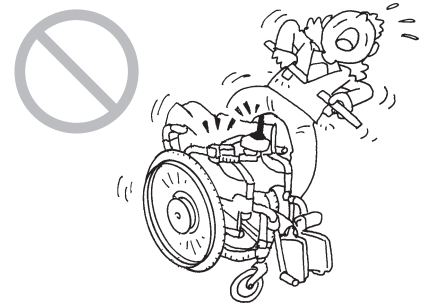

Do not operate with any heavy baggage hanging over the backrest, or with any heavy objects in the compartment. The wheelchair could easily fall backward on an inclined slope, and may cause you or other people around you to get injured.

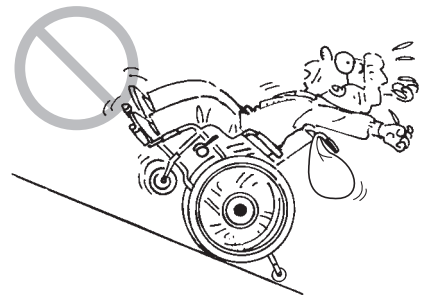

The wheelchair may tip over if it is operated with the anti-tip device removed, folded, or with the safety wheels facing upwards. Be sure to set the anti-tip device correctly and operate the wheelchair with the safety wheels in the correct position.



Do not connect any electric instruments to the battery seat plug. This plug is to connect PC for the Smart Tune software. Plugging other electric instruments like audio microphone or earphones may cause unit trouble. About the Smart Tune software, refer to section 11.

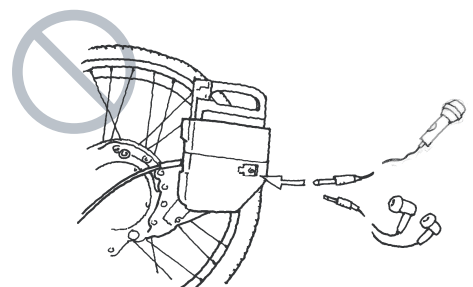

 **WARNING**

Do not hang anything on the joystick on the controller. It may get in the way of your operation, or the weight of the object may prevent the joystick from returning to its original position, even after your hand has released it.

In addition, if you put a rubber band around the joystick, it may get jammed inside the controller, causing the joystick to not return to its original position.

In either case, there is a risk of the wheelchair not stopping.

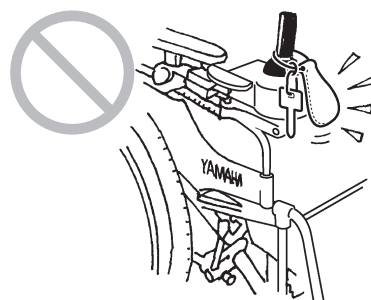

In areas with an incline, do not switch the clutch levers to the manual position. The wheelchair may start moving unexpectedly, and may collide or tip over.

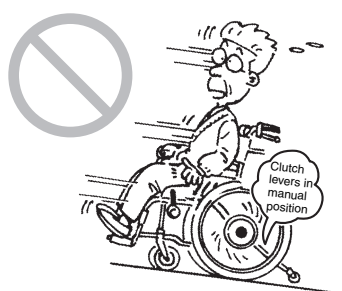

Do not operate the clutch levers while the wheelchair is in motion. There is a risk of collision or tipping over.

If you switch the clutch levers to the manual position while traveling in power drive, the motor brake loses its effect and the wheelchair may go out of control.

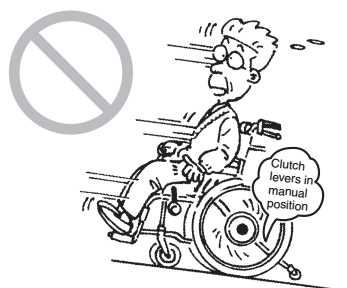

If you switch the clutch levers to the power drive position while traveling in the manual drive, brakes are applied to the rear tires. This abrupt braking can cause your body to plunge forward or damage the wheelchair.



 **WARNING**

Removing the battery while traveling causes the brakes to be applied to the rear tires, and may cause you or other people around you to get injured.

Turning off the power switch while traveling causes the brakes to be applied to the rear tires, and you or other people around you may get injured.



While the wheelchair is being operated or after operation, do not touch the back of the drive units. During or after operation, the back of the drive units may be hot. In addition, if the wheelchair is near a source of heat, the drive units may become hot.

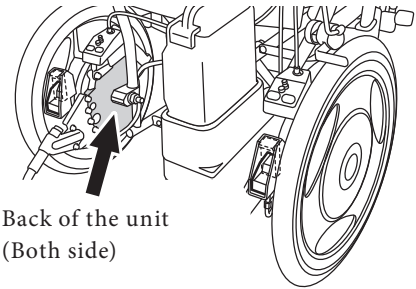

While operating the wheelchair, be careful not to get your hands tangled in the wheel spokes, wheel holes, etc.



The wheels of the E-Drive PLUS 16" are not equipped with hand rims. When operating the E-Drive PLUS 16", do not manually drive the wheelchair by holding its rear tires or wheels. You may injure yourself.



### 1.5.4. Getting In/Out of the Wheelchair, Seating

#### WARNING

When getting in the wheelchair by yourself or when the assistant has the user of the wheelchair get in the wheelchair, ensure that the wheelchair is on a level ground. If the user attempts to get in the wheelchair on an incline, he or she may lose balance and fall off the wheelchair.



To switch the clutch levers to the manual position, such as when starting assistant operations, apply the parking brakes on a level and stable ground, and then with the power turned off, switch the clutch levers.

If you are using a wheelchair with no parking brakes, have the assistant hold the wheelchair to ensure that it does not move. Failure to observe the above may cause the wheelchair to start moving unexpectedly, and may result in you or other people around you to get injured.



Do not lean out of the wheelchair to retrieve an item. Otherwise, you could fall off the wheelchair or the wheelchair could tip over.



### 1.5.5. General Operation

#### WARNING

Never ride the wheelchair with two people. The wheelchair may malfunction or the people riding it may get injured.



 **WARNING**

Never operate the wheelchair after consuming alcohol or taking medicine that causes drowsiness.



Never operate the wheelchair while holding an umbrella or other items.



Never tow the wheelchair. Do not use the wheelchair to tow or pull anything.

If you want to use a portable phone, etc., stop the wheelchair at a safe place and turn off the wheelchair. Moreover, while traveling in power drive, keep portable telephones and other electronic devices turned off. Otherwise, there is a risk of an accident.



Do not operate the wheelchair near a device that produces strong radio waves. If the wheelchair is near a source of radio waves and starts to operate abnormally, immediately turn off the power, and quickly move away from that location using the assistant operations or manual operation.

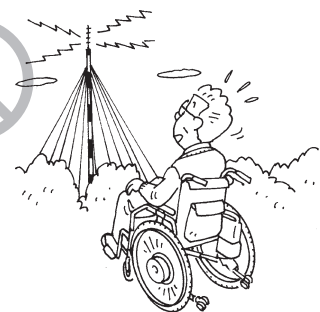

The weak electromagnetic waves emitted by the E-Drive PLUS may affect other electronic devices, such as automatic doors and the anti-theft systems of stores. In this case, turn off the power and operate the wheelchair using the assistant operations or manual operation.



**! WARNING**

Do not turn the power switch off while traveling. It causes the brakes to be applied to the rear wheels in some cases and may cause you to fall down from the wheelchair.



Do not use the wheelchair for transporting luggage or for any other purpose than to provide assistance to a disabled person.



Do not ride with clothing that is unsafe for wheelchairs, such as shown below. If you drive with such clothing, you or other people around you may get injured. Long scarves Clothing with loose sleeves Pants/skirts with wide hems, bare feet, sandals, slippers, ill-fitting footwear, etc.

Long scarves



Clothing with loose sleeves

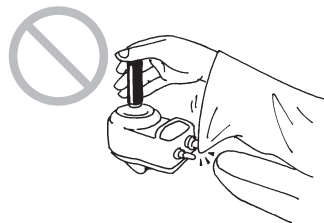

Pants/skirts with wide hems



Bare feet, sandals, slippers, ill-fitting footwear, etc.

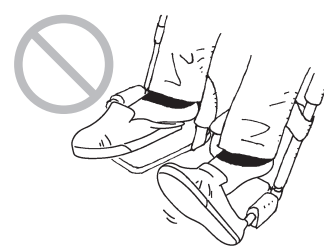

In the following environments and situations, you may need an assistant to accompany you and to operate the wheelchair for you.

In such cases, have an assistant accompany you. Traveling alone in these situations may lead to injury. Moreover, check to see if any dangers such as those shown below exist in the roads you use on a daily basis. If so, select a route that does not pass through such areas.

Always check the surrounding conditions to ensure safety.

### 1.5.6. Operation on Public Roads

#### WARNING

When the wheelchair is operated outdoors, its legal status is that of a pedestrian. Make sure to adhere to the rules and manners of a pedestrian.

On general roads, be careful of automobiles, bicycles, and pedestrians. In particular, pay the utmost attention to pedestrians.

Although the wheelchair can be operated on pedestrian-only roads, it cannot be operated where pedestrians are not allowed (car roads, in the middle of a road, etc.).

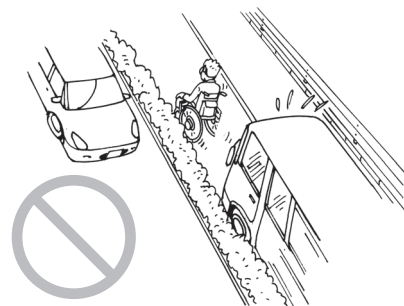

If the road has a sidewalk, operate the wheelchair on the sidewalk.

If the road does not have a sidewalk, operate the wheelchair on the side strip of the road where pedestrians walk.

If the road does not have a side strip, operate the wheelchair on the side of the road where pedestrians walk.

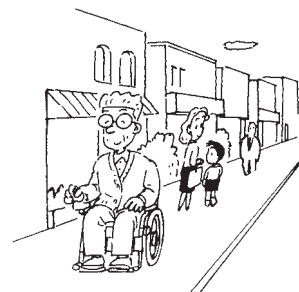

If two or more wheelchairs are traveling together outdoors, the wheelchairs should be operated in a single line with sufficient space between the wheelchairs. The wheelchairs should not be operated side by side.

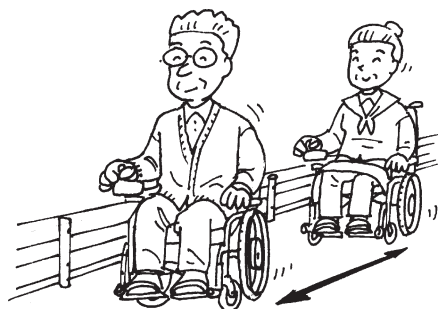

When starting off or moving backward, be careful of other people and obstacles around you.

It is extremely dangerous to travel on a narrow street without a sidewalk. Choose a safer path whenever possible.

 **WARNING**

Be careful not to travel too close to the edge when traveling on an embankment, etc., of a road. Depending on the condition of the shoulder of the road, you could accidentally move off the road.



When traveling on a sidewalk that does not have a guardrail, there is a risk of falling into the street side. Have an assistant accompany you instead of traveling alone.

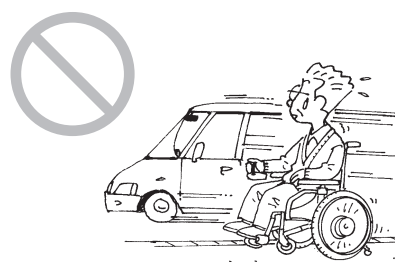

When traveling near a ditch, the tire may fall into it if there is a gap even if it is covered. Have an assistant accompany you instead of traveling alone.



If there are any obstacles, stop the wheelchair and check in front of you and behind you for safety before proceeding.

If an oncoming vehicle is near, stop the wheelchair, wait for the vehicle to pass, and then check in front of you and behind you for safety before proceeding.



Do not operate the wheelchair outdoors at night. Not being able to see the road conditions, you may lose balance and fall, or people or cars may collide into you if they cannot recognize you.



## ! WARNING

If it is raining or snowing, do not operate the wheelchair outdoors. Automobiles and other vehicles may collide into you if they cannot recognize you. If it starts to rain or snow while you are outdoors, move indoors as soon as possible.



### 1.5.7. Operation on Slopes

## ! WARNING

The wheelchairs equipped with the E-Drive PLUS are built to be lighter compared to other heavier electric wheelchairs that use a general lead battery. For this reason, when a person sits in it, the overall center of gravity shifts higher. Therefore, caution is necessary when traveling on a slope.

Do not use the wheelchair on a slope steeper than 6 degree (10% grade). It may tip over or the brake may become ineffective.

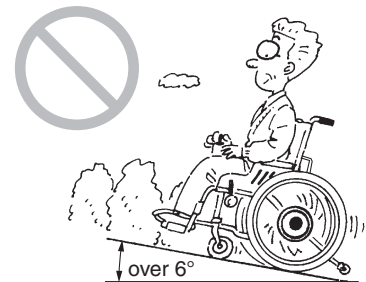

When going up/down a particular slope for the first time, have an assistant accompany you to ensure safety.

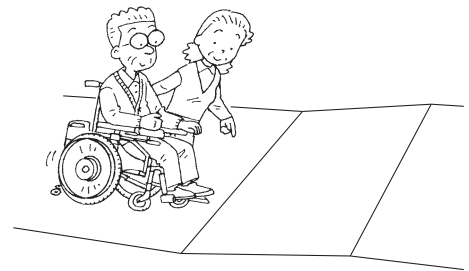

In areas with an incline, do not switch the clutch levers to the manual position. The wheelchair may start moving unexpectedly, and may collide or tip over.

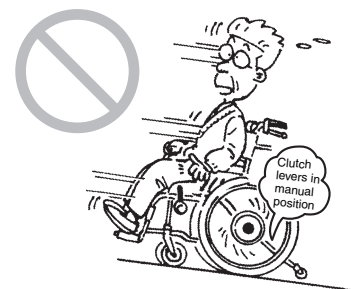

 **WARNING**

Do not abruptly turn on a downhill slope. In addition, do not traverse horizontally or diagonally across a steep slope. You could easily lose balance and tip over.



On a downhill slope, start the braking operation early. The braking distance on a downhill slope may be significantly longer than when traveling on level ground.

In the areas where the wheelchair leans sharply to the left or right, the wheelchair may tip over sideways. Have an assistant accompany you.



When descending down a slope with the assistant operations, descend in reverse. If the assistant moves the wheelchair forward when descending, the passenger may plunge forward and fall off the wheelchair.

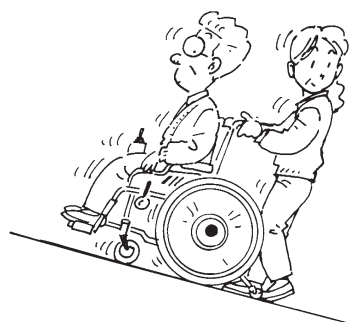

### 1.5.8. Going Up/Down Curbs

 **WARNING**

The wheelchairs equipped with the E-Drive PLUS are built to be lighter compared to other electric wheelchairs that use a general lead battery. For this reason, when a person sits in it, the overall center of gravity shifts higher. Therefore, caution is necessary when traveling on a curb.

When traveling in power drive mode, the wheelchair can clear level differences of approximately 20 mm (varies depending on the caster size). Any greater level differences should be cleared by an assistant by manual push operation.

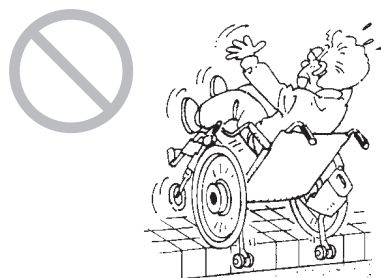

**! WARNING**

When going up/down a curb for the first time, have an assistant accompany you instead of traveling alone.

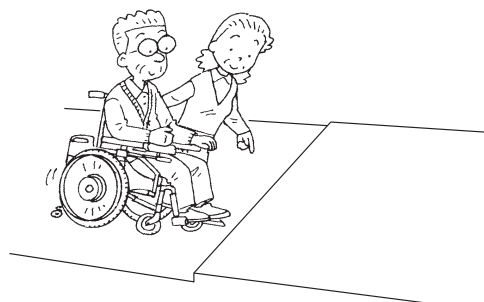

When traveling over a curb, be careful not to lose your balance.

When traveling over a curb, proceed at a right angle to the curb. Do not traverse the curb diagonally.



Because the front casters are small, they are able to travel over only small curbs. Therefore, caution is necessary when traveling over curbs in power drive mode.



When traveling between a sidewalk and a road, be careful of curbs.

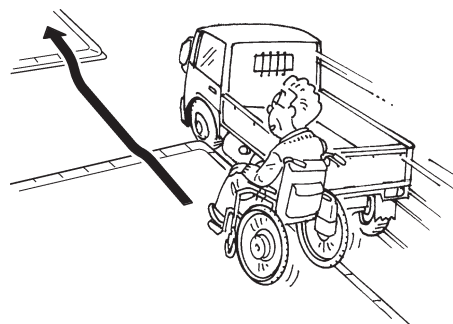

To travel over a curb or other obstacles with the assistant operations, turn off the assistant controller and go over it manually. If the assistant goes over a curb or other obstacles in power drive mode, the assistant could easily lose balance and the passenger or assistant could get injured if the wheelchair tips over.

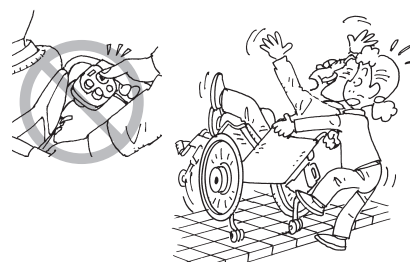

**! WARNING**

When descending from a curb with the assistant operations, descend in reverse. If the assistant moves the wheelchair forward when descending, the passenger may plunge forward and fall off the wheelchair.

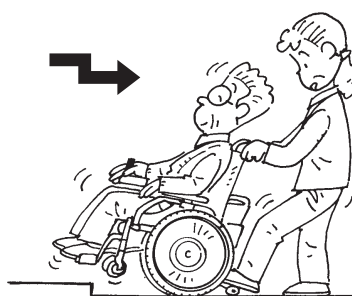

When going up/down a curb with the assistant operations, the safety wheels of the anti-tip device may be raised or folded temporarily depending on the height of the curb. After traveling over the curb, be sure to place the safety wheels of the anti-tip device in the correct position before operating the wheelchair.



**1.5.9. Crossing Roads**

**! WARNING**

You cannot cross a road where pedestrians are prohibited from crossing.

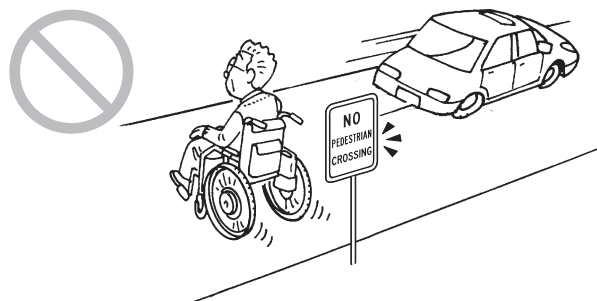

When crossing at an unfamiliar location, have an assistant accompany you.

If the residual capacity of the battery is low, the wheelchair may stall while crossing a street. Check the residual capacity of the battery before crossing.

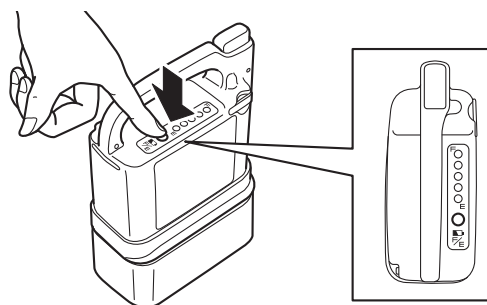





## WARNING

Before crossing a road, be sure to check to the left and right for safety.

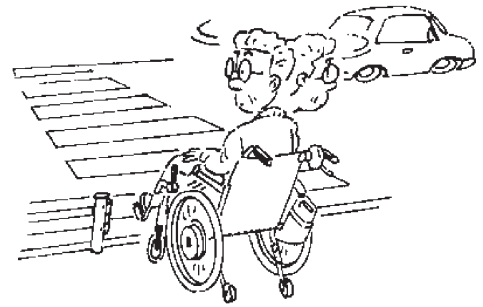

Do not cross a road if it is dangerous to do so, such as if an automobile is approaching.

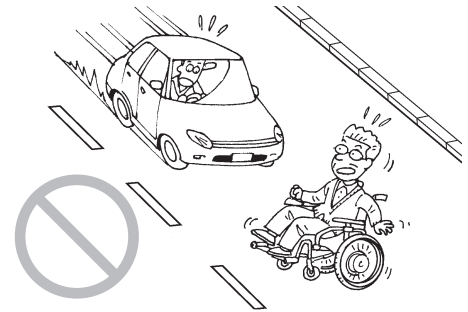

When crossing a road, proceed as close as possible at a right angle to the road. Do not cross the road diagonally.

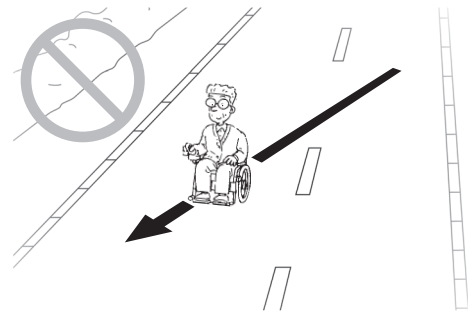

Cross a road at a location where there is a traffic light or crosswalk.

When crossing a street at a crosswalk with no traffic light, pay sufficient attention to the traffic.

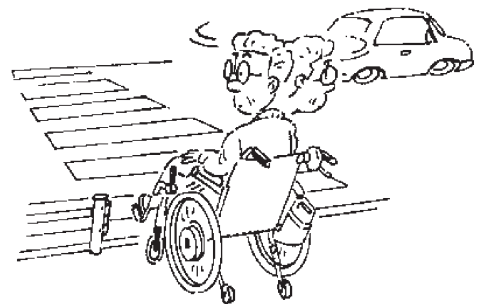

If there is a pedestrian signal light, obey the signal light. If the signal light is flashing green or is red, you must not start to cross the road. If the street is wide, the signal may change before you finish crossing. In such places, wait for the next green light to give yourself enough time to cross the street.

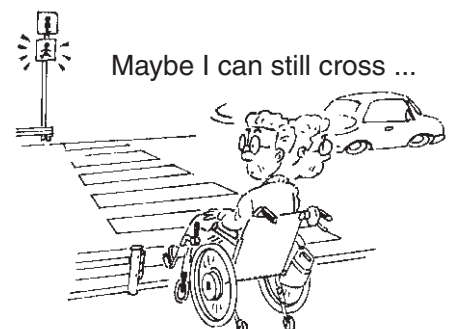

 **WARNING**

At intersections where there are no traffic lights or crosswalks, stop in the following three stages.

1. Stop before entering the road.
2. Stop where you can be seen by automobiles.
3. Stop where you have a good view of the road.

1.5.10. Railroad Crossings

 **WARNING**

Avoid railroad crossings if you can go around them.

If you have no choice but to travel over a railroad crossing, have an assistant accompany you.



Be sure to stop before the railroad crossing and check to the left and right for safety.

When traveling over a railroad crossing, proceed as close as possible at a right angle to the railroad tracks. If you travel diagonally, the wheelchair casters may get caught in the railroad tracks.

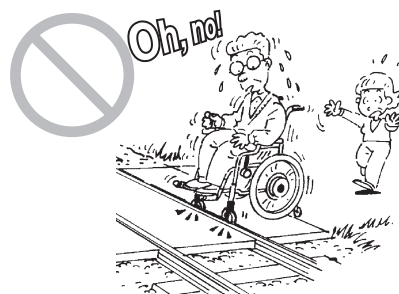

Be careful not to travel too close to the edge when traveling over a railroad crossing. Otherwise, the wheels could accidentally move off the railroad crossing.

If case of an emergency, do not panic. Have the assistant or a person around you push the emergency button and move off the railroad crossing as quickly as possible.

### 1.5.11. Poor Road Conditions

#### WARNING

The wheelchairs equipped with the E-Drive PLUS or the are built to be lighter compared to other electric wheelchairs that use a general lead battery. For this reason, when a person sits in it, the overall center of gravity shifts higher. Therefore, caution is necessary when traveling on a curb.

Do not travel on gravel roads, bumpy roads, muddy roads, footpaths, etc. If you have no choice but to travel on such roads, have an assistant accompany you.



Do not drive the wheelchair on a frozen surface. You may not be able to stop the wheelchair.



Go around locations where snow or water has accumulated or have an assistant accompany you. In such places where you do not know the road conditions or if the wheelchair slips, you could lose control or the brakes may become ineffective. If the wheelchair travels through a deep puddle and water enters the drive units, the wheelchair could stop.



If you see a dip in the road, or if a sidewalk dips due to a car ramp, go around it. If you go straight into it, the wheelchair may tip over. If you have no choice but to keep going, do so with an assistant accompanying you to ensure safety.

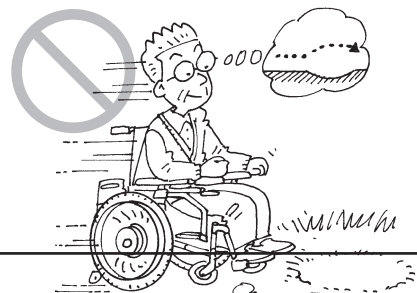

### 1.5.12. Parking Lots

#### WARNING

Do not travel directly behind or in front of automobiles in parking lots. Drivers may not be able to see you if you are directly behind or in front of their automobiles.

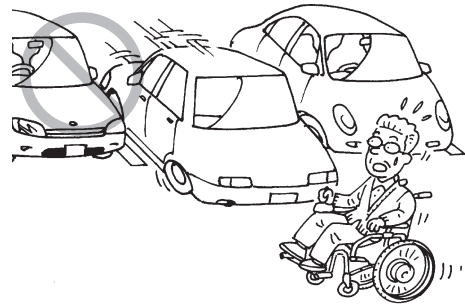

Do not travel between automobiles in parking lots. Otherwise, you could damage the automobiles or be crushed when an automobile starts moving.



### 1.5.13. Using Public and Private Transportation

#### WARNING

When using public transportation, check to ensure that wheelchair use is allowed beforehand. In addition, follow the rules and instructions when boarding the vehicle.

When using a private automobile, do not use the wheelchair as a seat. Sit in one of the automobile's seats.

When getting on/off a lift vehicle, always have an assistant accompany you to ensure safety.

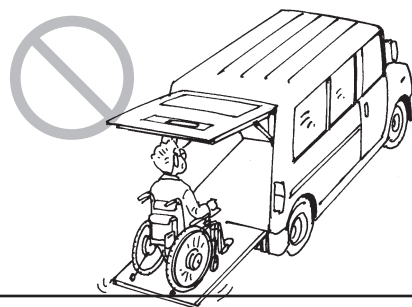

When using a train station, always have an assistant accompany you, stop the wheelchair on the train station platform so that it is parallel to the railroad tracks, and be sure to apply the parking brakes. Some train station platforms are positioned at a slight angle to the railroad tracks. In some cases, you could fall onto the tracks and be injured.

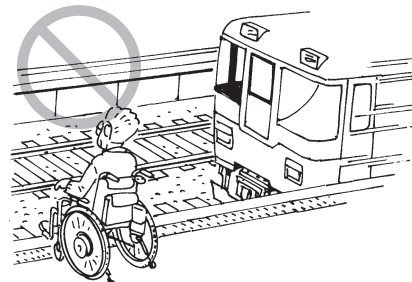

**! WARNING**

When getting on/off a bus or train, always have an assistant accompany you to ensure safety.

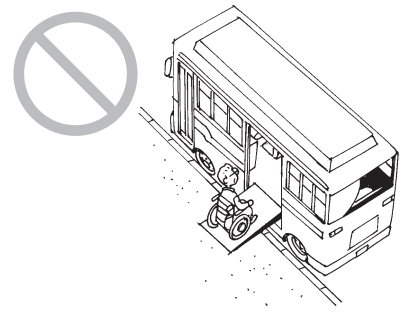

Whenever you get off a bus, a taxi, or a train, be sure that the safety wheels on the anti-tip device are in the correct position before getting in the wheelchair.



**1.5.14. Crowded Areas**

**! WARNING**

When getting in the wheelchair in a crowded area, do so with sufficient attention to your surroundings. If you bump into people or objects, your body may plunge forward, or other people around you may get injured.



When you are stopped in a crowded area, be sure to turn off the power. If a person in your surrounding area hits the joystick with his or her hand or arm, the wheelchair may start moving unexpectedly, causing injury to people around you.

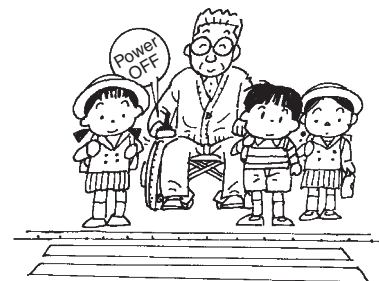

### 1.5.15. Transporting and Storing the Wheelchair

#### WARNING

When lifting a wheelchair with tilt-up arm support, never lift it by the arm support. Otherwise, the arm support may come off and cause an injury or damage to the equipment.

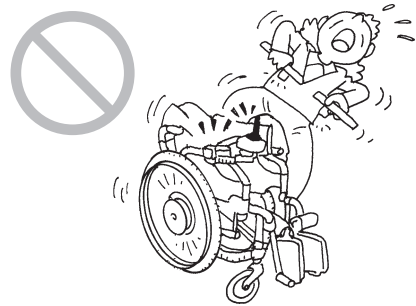

When lifting a wheelchair, never lift it by the battery, cable, or controller. Otherwise, any of these devices may come off and cause an injury or damage to the equipment.



Do not turn the wheelchair upside down. Doing so may cause parts of the wheelchair to fall off, resulting in an injury or damage to the equipment.

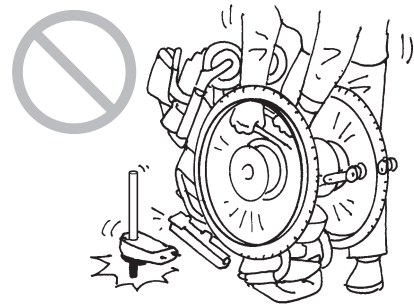

Do not put your hands or fingers beside or under the seat pipe. Doing so may cause your finger(s) to get pinched.

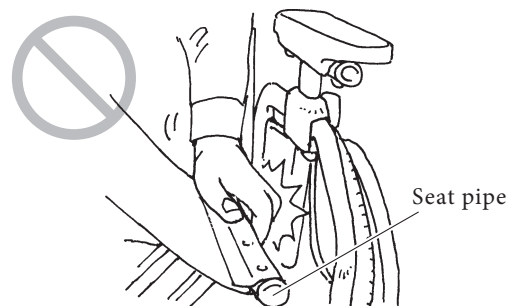

During transport, do not place the battery or the wheelchair in a place that can become hot, or in direct sunlight.

This could lead to malfunction, or could cause the deterioration of the battery to progress rapidly.

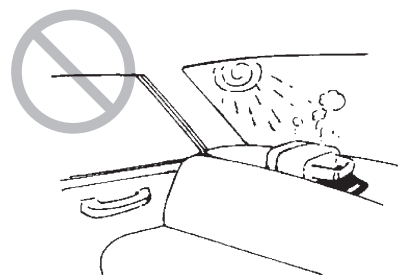



## WARNING

Be sure to remove the battery when not in use, so that its power will not turn on unexpectedly in storage or during transport.

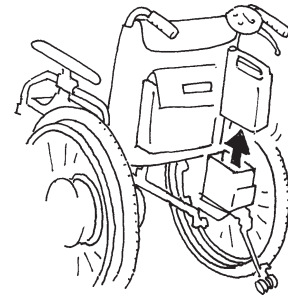

Be sure to store the disconnected battery with the protective cap on it. Exposed contacts can cause short circuits and lead to a fire or battery rupture.



Protective cap

Do not store in places that can get wet by rain, or that are high in humidity.

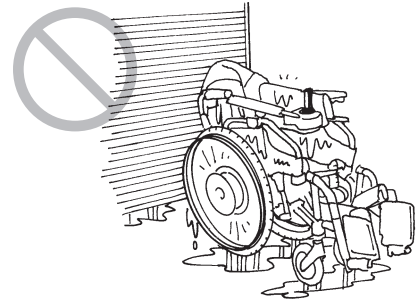

Do not store when it has been wet for a long time, or there is dirt on it. This can cause malfunction.

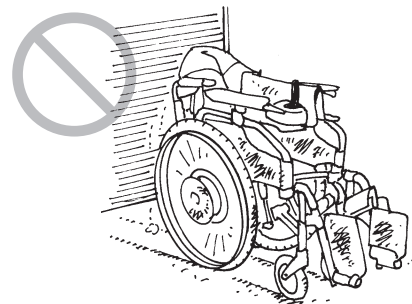

Avoid storing in direct sunlight or in places where the temperature can get high.

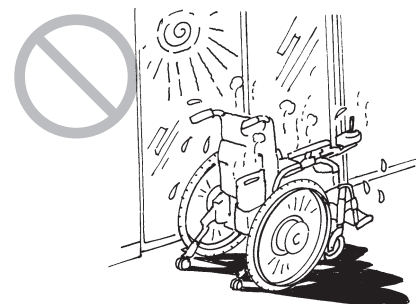



**! WARNING**

Do not wash by directly hosing it down with water. Also, do not wash with using steam. The electronic devices can get damaged, which may lead to malfunction.

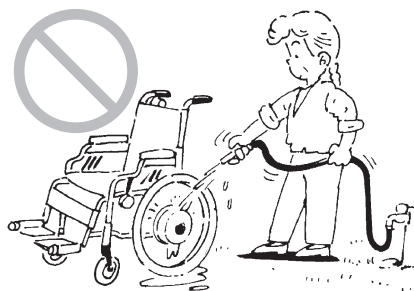

Do not clean with solvents such as gasoline or paint thinner. This may damage the painting and plastic parts.

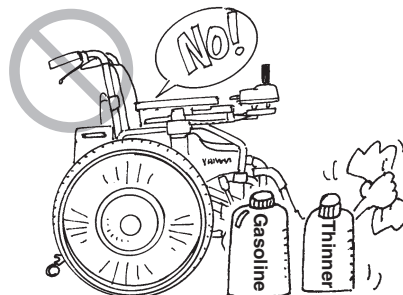

**1.5.16. Assistant Operations in an Emergency**

**! WARNING**

During assistant operations in case of an emergency, the assistant should switch the clutch levers to the manual position, and move the wheelchair to a safe location.



# 1.6. Warning Label Location Diagram

## • Power Unit and Controller

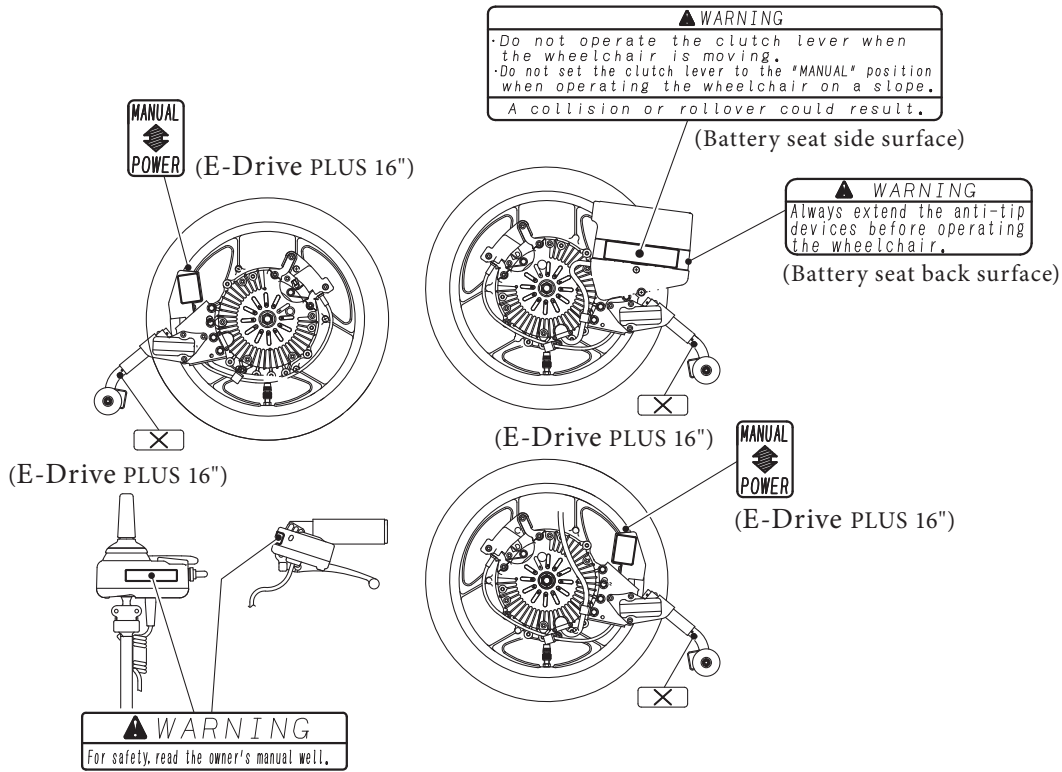

## • Lithium Ion Battery and Charger

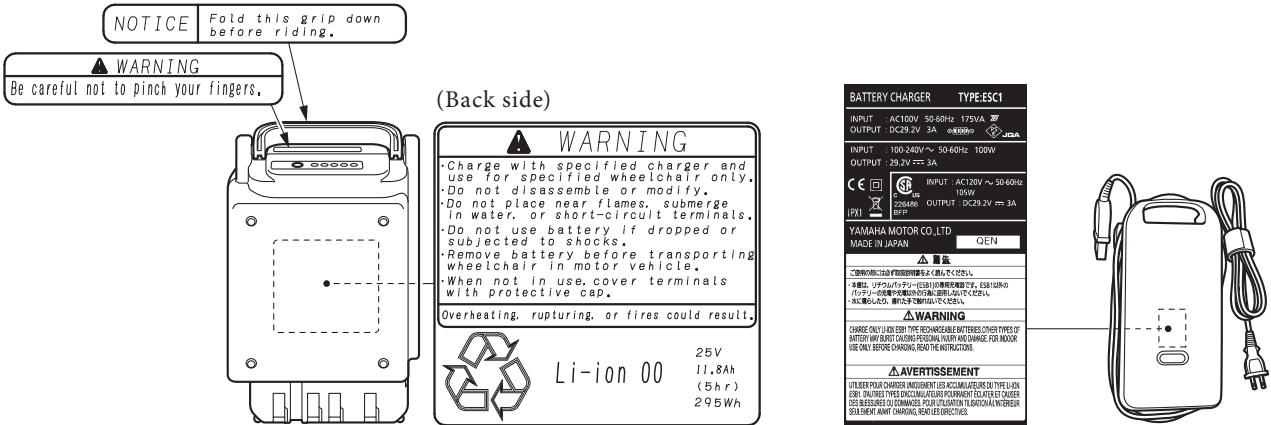

## • Nickel Metal Hydride Battery and Charger

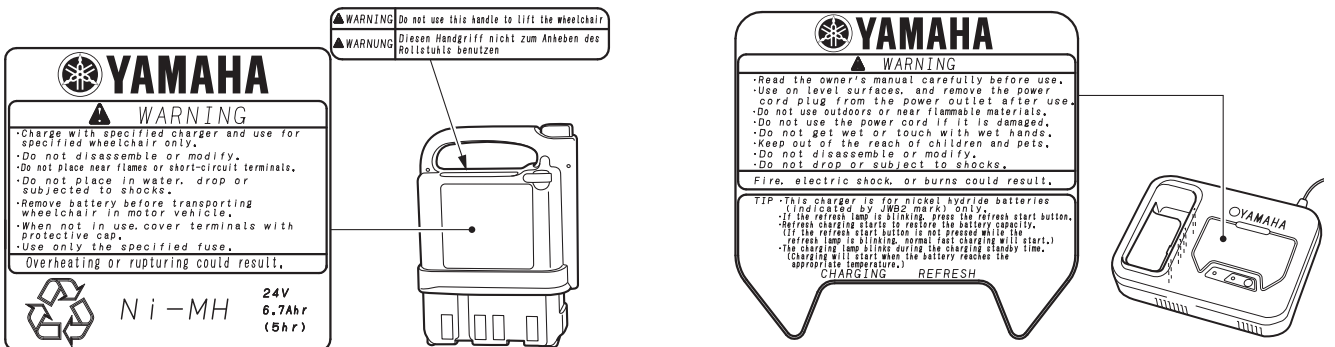

## 2. Names of Parts

### 2.1. E-Drive PLUS 24"

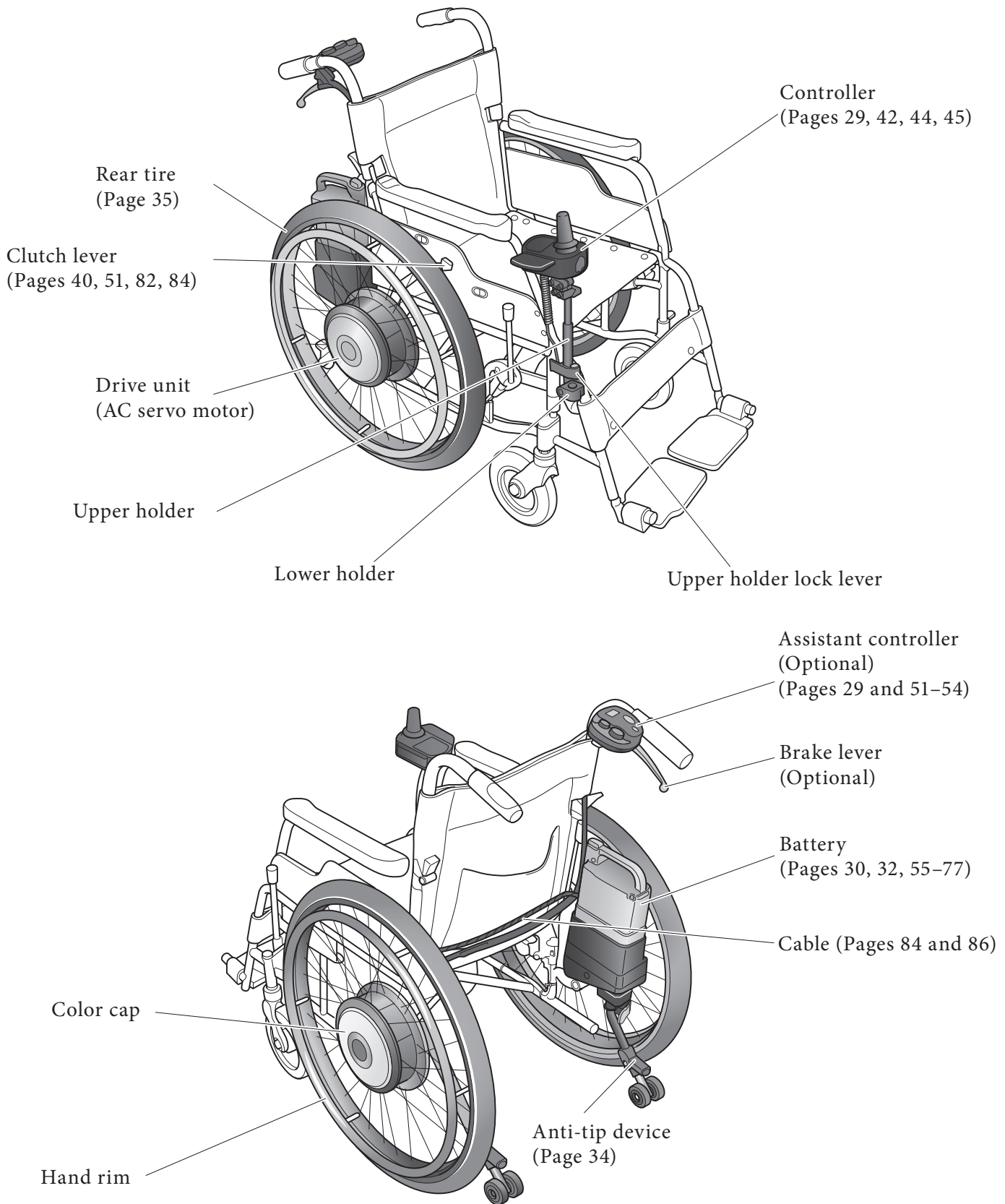

Either a nickel hydride battery set or a lithium ion battery set is supplied.

## 2.2. E-Drive PLUS 16"

2

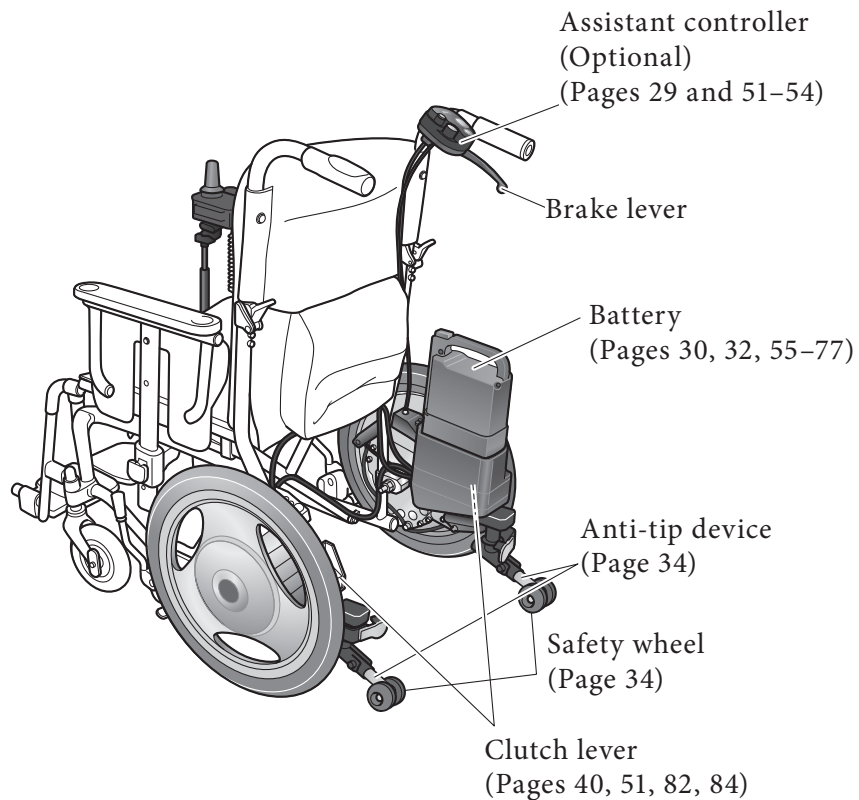
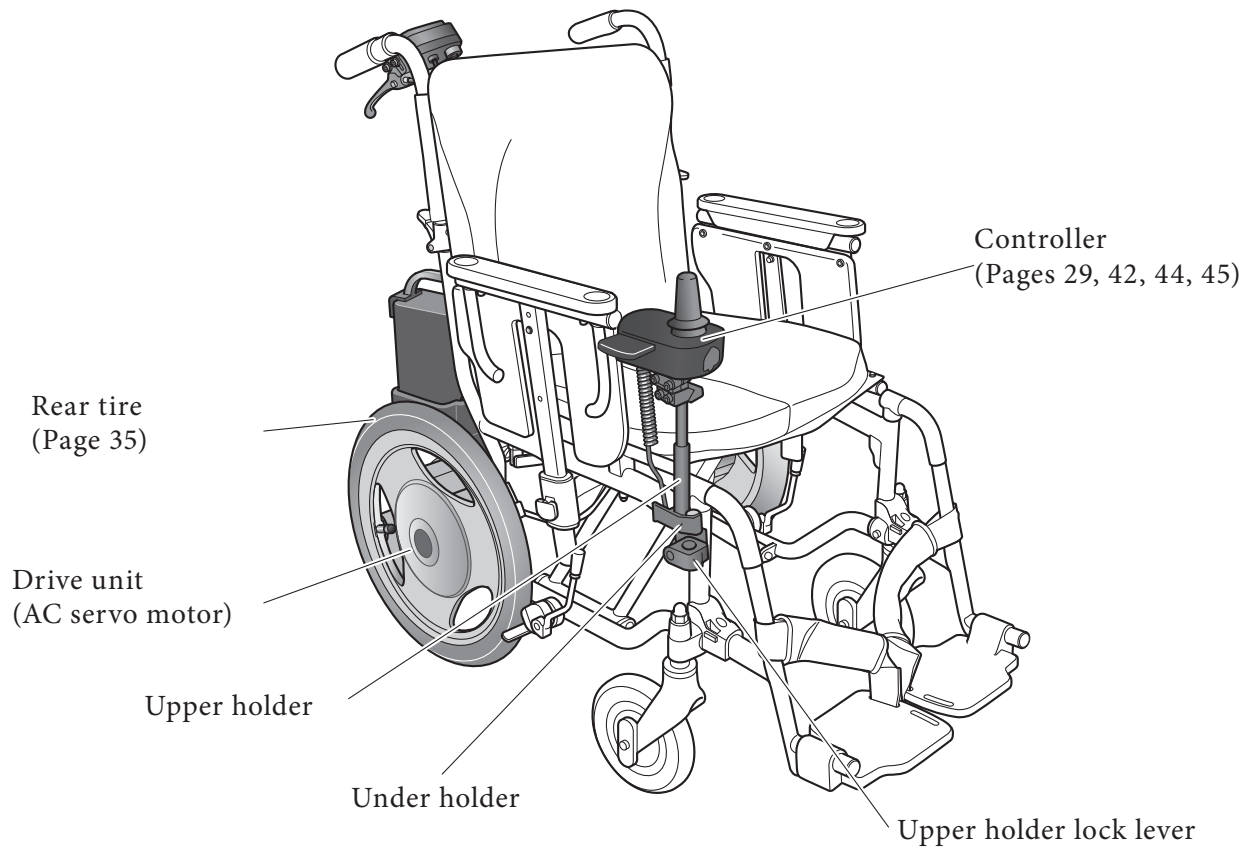

Either a nickel hydride battery set or a lithium ion battery set is supplied.

## 2.3. Controller

(Pages 36, 42–45)

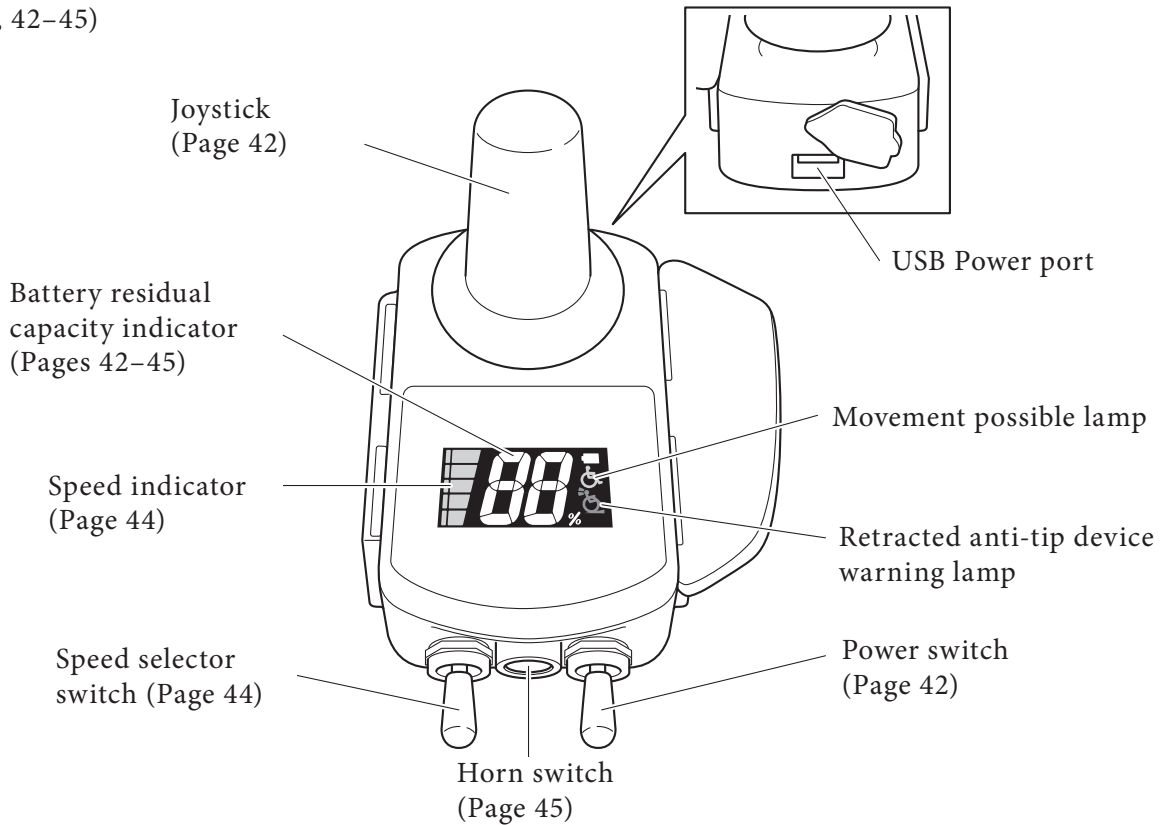

### NOTICE

The USB power port is used only to supply power. It does not feature any communication functions.

The capacity of the USB power port is 500 mA.

It is not capable of charging / using a USB device that requires a power current greater than 500 mA.

Do not insert any object other than a USB connector into the USB power port.

Otherwise, the USB power port may be damaged.

When not using the USB power port, be sure to install its rubber cap.

## 2.4. Assistant Controller (Optional)

(Pages 51–54)

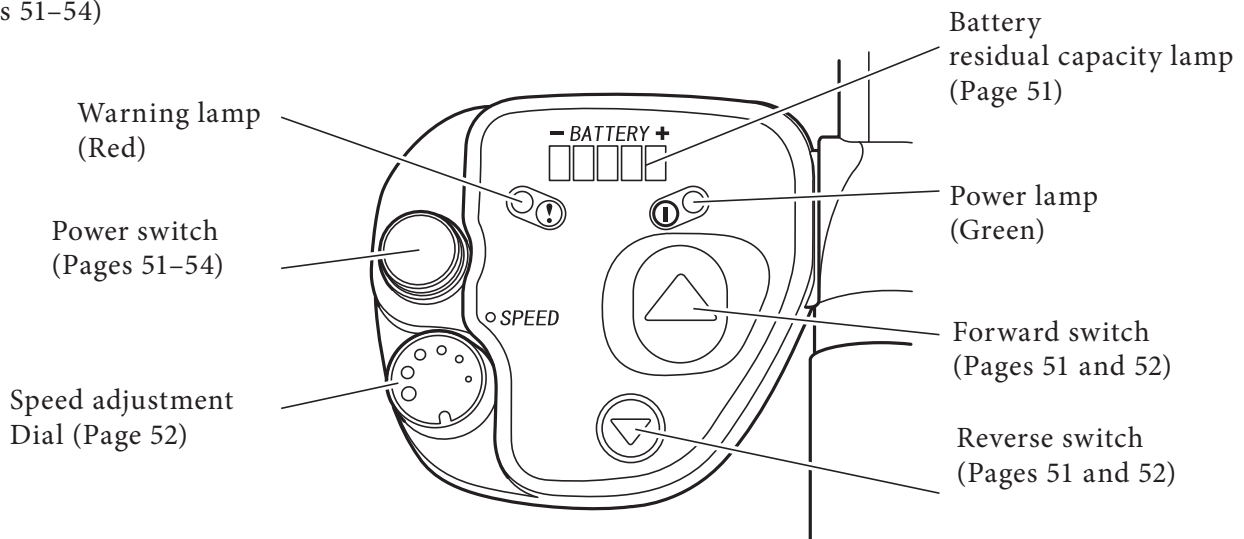

## 2.5. Nickel Metal Hydride Battery (JWB2)

2

Indicator switch  
(Pages 38, 59, 62, 64)

Grip (Handle)

Release button (Yellow)  
(Page 50)

Capacity indicator lamp  
(Pages 38, 59, 62 and 64)

Battery fuse (Yellow 20 A)

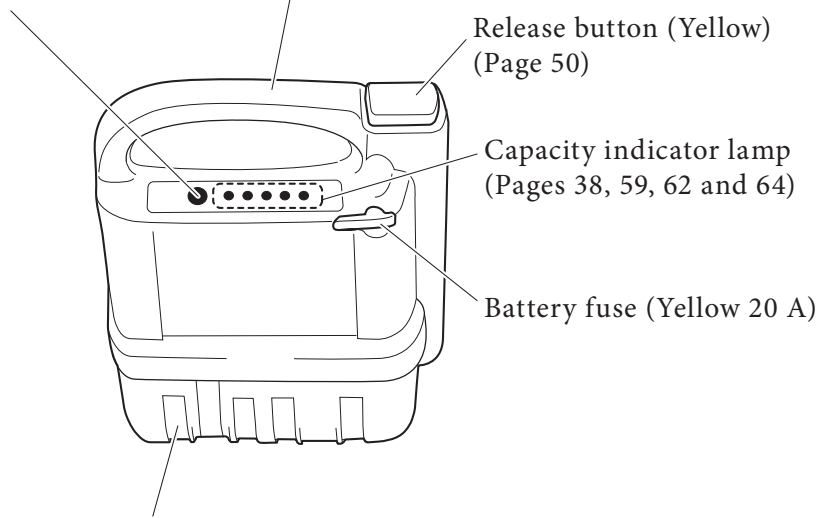

Contacts  
(Page 38)

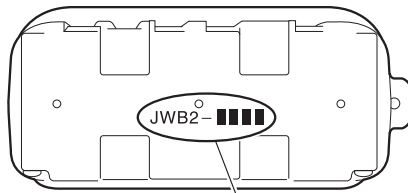

A code indicating the model (JWB2) and  
the manufactured lot is printed.

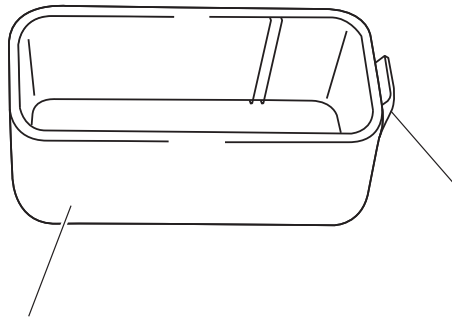

Spare battery fuse  
(Yellow 20 A)

Protective cap

### NOTICE

If the battery fuse blows, instead of replacing it by yourself, consult with your dealer. If you replace the fuse without eliminating what caused it to blow, the fuse may blow again, or the main unit may malfunction.

## 2.6. Nickel Metal Hydride Battery Charger (JWC-2)

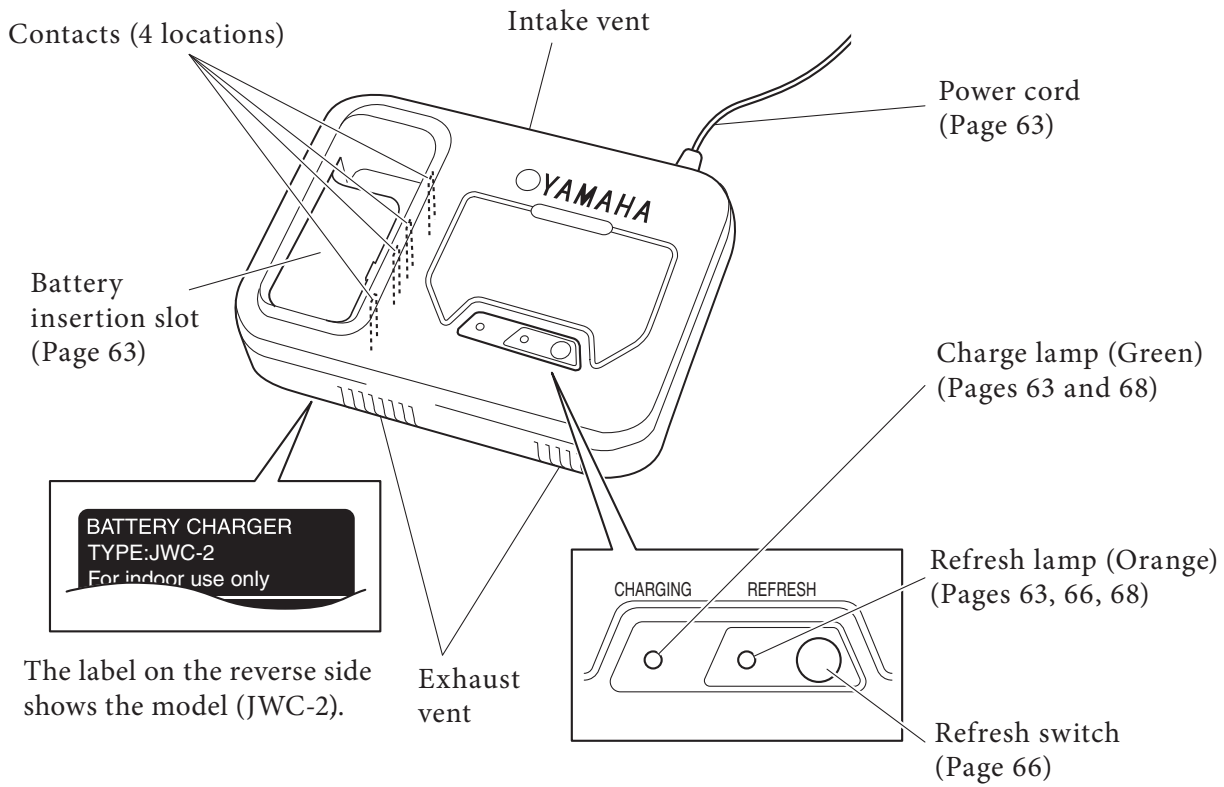

## 2.7. Lithium Ion Battery (ESB1)

2

Indicator switch  
(Pages 38, 69, 74, 76)

Grip (Handle)

Capacity indicator lamp  
(Pages 38, 69, 72, 74, 76)

Contacts  
(Page 38)

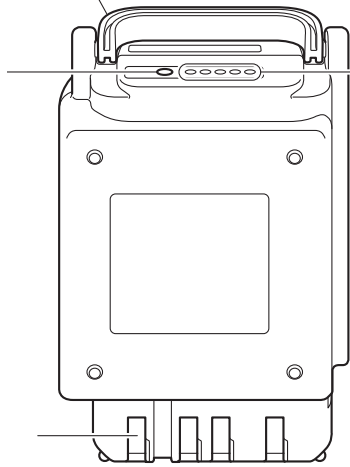

Connector cover  
(Pages 74 and 75)

Connector for charger  
(Pages 74 and 75)

Manufactured date  
displayed (Bottom)  
(Page 73)

Shows the model.  
(ESB1)

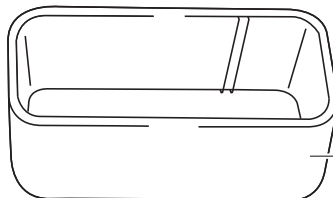

Protective cap



## 2.8. Lithium Ion Battery Charger (ESC1)

2

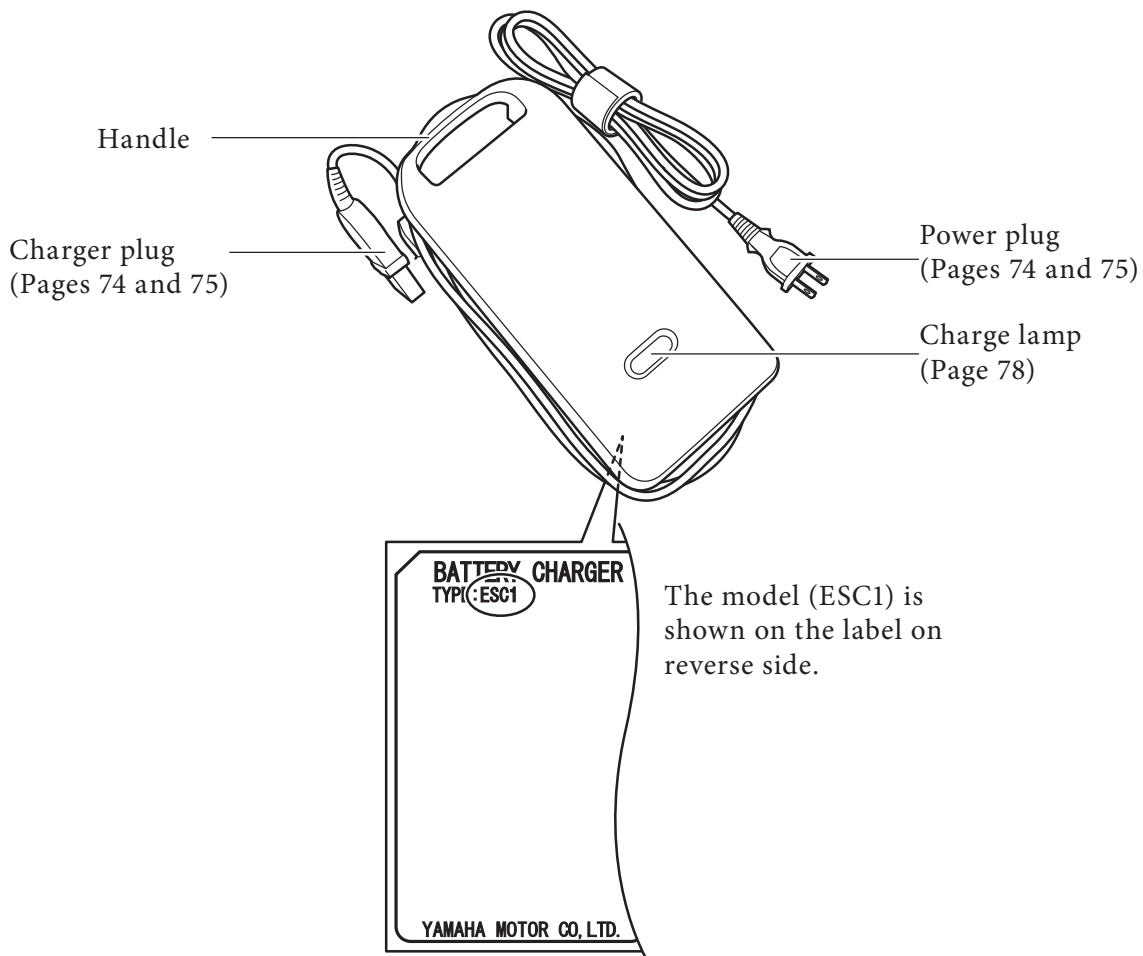

# 3. Before Sitting in the Wheelchair

## 3.1. Inspecting the Wheelchair

Inspect the wheelchair. If you detect any problem, contact your dealership.

### (1) Anti-tip device

Check the anti-tip device to ensure that it is not deformed or greatly damaged.

Check the safety wheels of the anti-tip device to ensure that they are in the correct position for operation.

For details, refer to the wheelchair frame manual.

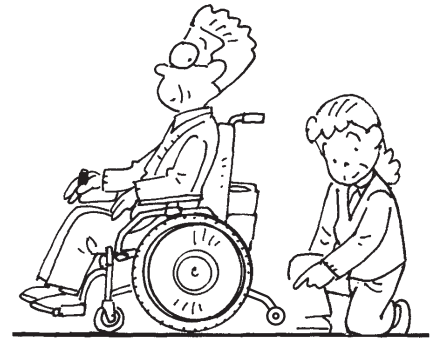

- Move the anti-tip device as shown in the figure to ensure that it is locked in position.

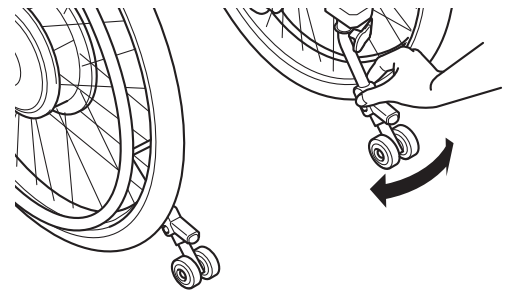

- If the anti-tip device is not locked in position, perform the following actions as shown in the figure until you hear a click confirming that the lock is engaged.
  - (a) Extract the anti-tip device.
  - (b) Move the anti-tip device back and forth to ensure that it is locked in position.

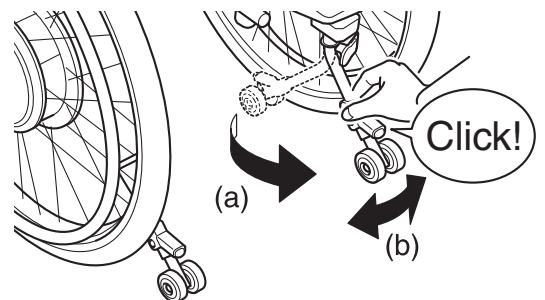

 **WARNING**

The wheelchair may tip over if operated when the anti-tip device is removed or the safety wheels are not in the correct position. Do not operate the wheelchair when the safety wheels are not in the correct position. Only have the safety wheels folded or facing upwards when going over bumps with the assistant operations and other such situations. Continuing to use the wheelchair with a problem in the wheelchair body or the wheels may cause sudden damage to the wheelchair while traveling, and may result in a rollover or fall.

(2) Rear tire

Check to ensure that there is tire depth.

Check the surface of the tire to ensure that there are no cracks in it.

Check to ensure that there is air in the tire. (Check by pressing the tire with your finger.)

If not enough, pump up to 4,5 Bar for E-Drive PLUS 24" or 3,45 Bar for E-Drive PLUS 16".

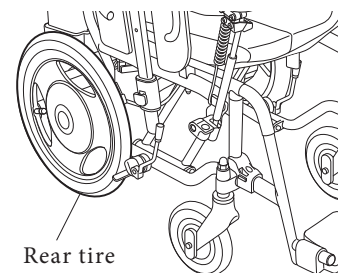
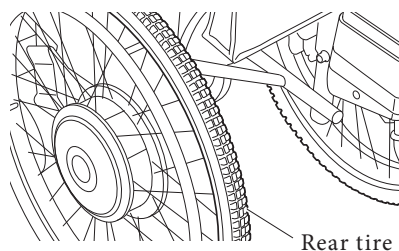

(3) Parking brakes

Check to make sure that the parking brakes are applied.

Push the wheelchair with the brakes applied on both wheels to ensure that the tires do not move.

Check the parking brakes to ensure that they do not wobble.

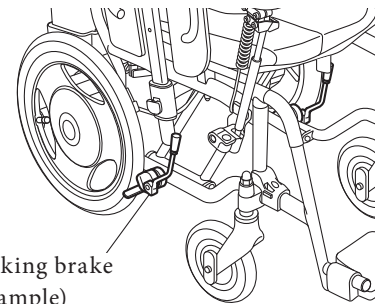
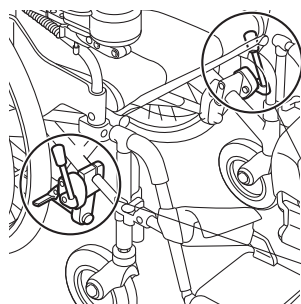

## (4) Wheels

Check the wheels to ensure that they are not deformed or damaged. Check the area where the wheel meets the frame to ensure that it does not wobble.

Check the spokes to ensure that they are not broken.

In case of the detachable units, make sure that the axle stopper balls are visible and that the axle shafts are securely locked so that the units will not come off.

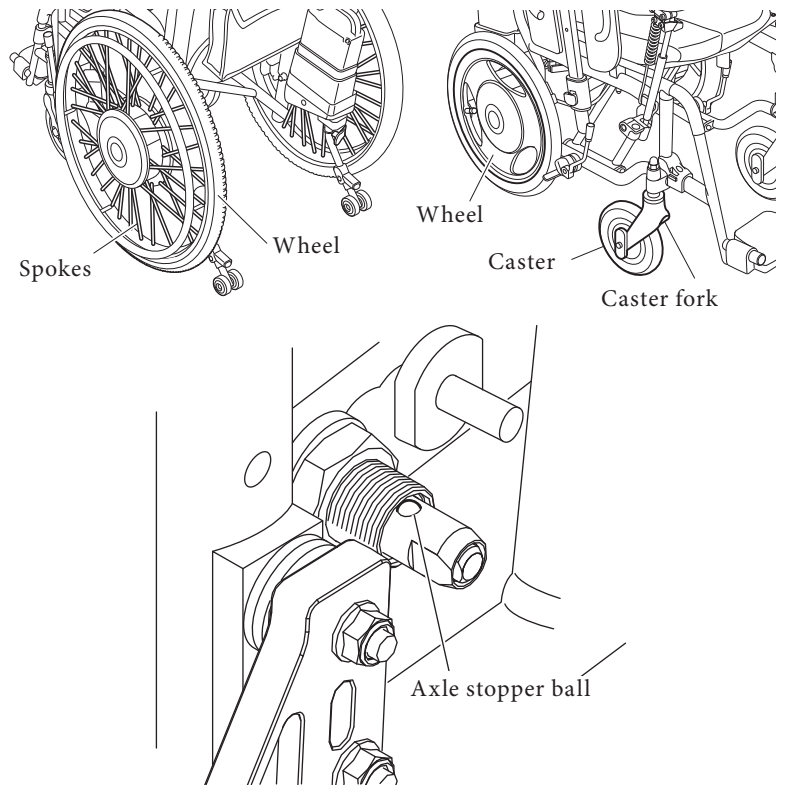
**WARNING**

**If the wheels are not installed properly, they might come off during riding. Before using the wheelchair, make sure that the wheels do not come off.**

## (5) Casters

Check to ensure that the casters are Min. size 6".

Check to ensure that there is tire depth.

Check the tires to ensure that they are not damaged.

Check the caster forks to ensure that there are no cracks in them.

Check the nuts to ensure that they are not loose.

**WARNING**

**If the air pressure in the rear tires decreases, the parking brakes may become ineffective. Always keep the air pressure in the rear tires at the correct level.**

**Continuing to use the wheelchair with a problem in the wheelchair body or the wheels may cause sudden damage to the wheelchair while traveling, and may result in a rollover or fall. If you find any unusual condition on the wheelchair in these inspections, contact your dealership.**

## (6) Controller

Check the controller to ensure that it is firmly secured to the wheelchair. (Try shaking and rocking the controller.)

Check the joystick to ensure that it is in an easy-to-operate position.

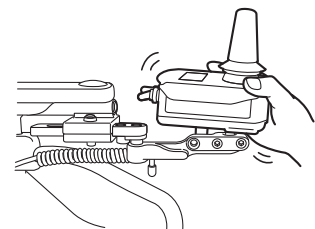

(7) Assistant controller (optional)

Check the assistant controller to ensure that it is firmly secured to the wheelchair. (Try shaking and rocking the assistant controller.)

Check the switches to ensure that it is in an easy-to-operate position.

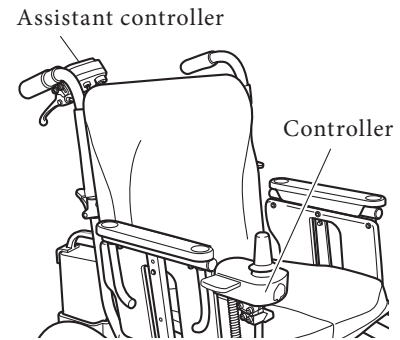

(8) Battery bag (optional)

Make sure that the left and right cable connectors are securely connected.

Make sure that the entire surfaces of the fasteners on the upper straps and lower fixing belt are adhered completely and securely.

Make sure that the upper straps and lower fixing belt are not loose, and do not have any slack.

(9) Foot supports

Make sure that the clearance between the foot supports and the ground is 5 cm or more.

Adjust the height of the foot supports to make 5 cm or more clearance.

 **WARNING**

Set the height of the foot supports so that the clearance between the foot supports and the ground is 5 cm or more. If the foot supports are too low, the foot supports may come in contact with bumpy ground or objects on the ground, possibly causing the wheelchair to tip over.

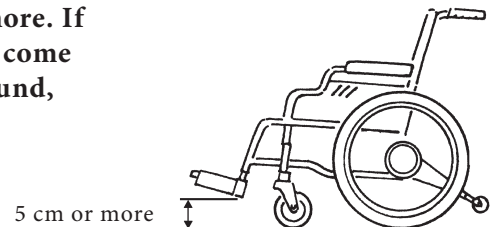

## 3.2. Checking Your Clothing

Wear bright-colored, easily visible clothing when operating the wheelchair. Do not operate the wheelchair while wearing clothing that is not suitable for wheelchair use. Refer to “1.5.5. General Operation” (Page 9).

 **WARNING**

Do not travel with clothing that are not safe for wheelchairs. If you drive the wheelchair with such clothing, you or other people in your surrounding may become injured.

### 3.3. Checking the Residual Capacity of the Battery and Installing the Battery on the Wheelchair

- (1) Press the indicator switch to check the residual capacity of the battery. The residual capacity of the battery will be displayed on the capacity indicator lamps.

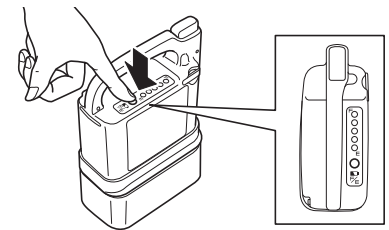

- (2) Check the contacts to ensure that they are not dirty or rusted. If the contacts are dirty or severely rusted, the wheelchair may be rendered immobile.

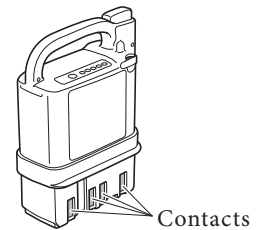

- (3) Install the battery on the wheelchair.

#### <How to install a nickel metal hydride (Ni-MH) battery>

Turn off the power switch

Insert the battery until it clicks into place.

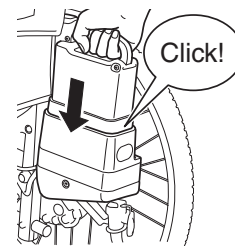
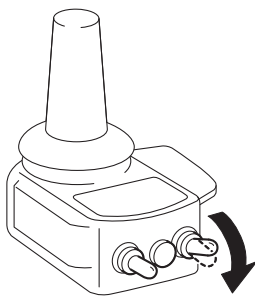

#### <How to install a lithium ion (Li-ion 00) battery>

Turn off the power switch.

Insert the battery.

1 Pull the grip down to the side.

2 Firmly insert the battery.

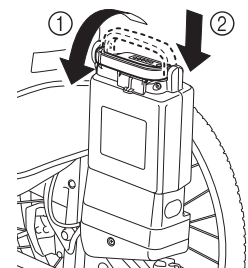
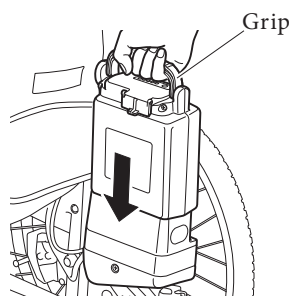
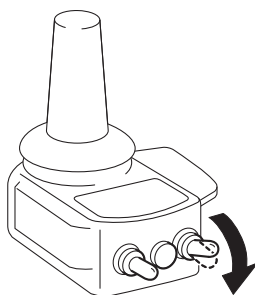

#### WARNING

Do not drop or apply an impact to the battery.  
This may cause the battery to become damaged, overheat, or rupture.  
Do not insert the battery if the battery slot is dirty or wet.  
This may cause a short circuit and lead to a fire or battery rupture.



## WARNING

When handling the lithium ion battery, ensure that you do not pinch your finger with the grip. Doing so may injure your finger.

## *NOTICE*

Do not replace the battery when the power is turned on. Doing so may damage the battery terminals and cause a malfunction.

## 4. Riding the Wheelchair

### 4.1. Sitting in the Wheelchair

- (1) Place the wheelchair in a level and stable location and turn off the power switch (yellow)
- (2) Put the clutch levers of the left and right power units in the power drive position.

1 Power drive..... Traveling in power drive is possible. The brakes are applied when not traveling. Normally, use the wheelchair in this state.

2 Manual..... The brakes are released and the assistant can push the wheelchair by hand.

- (3) Apply the parking brakes. If the wheelchair has no parking brakes, the assistant must hold it firmly.
- (4) Get into the wheelchair and firmly sit down so that you will not fall out.

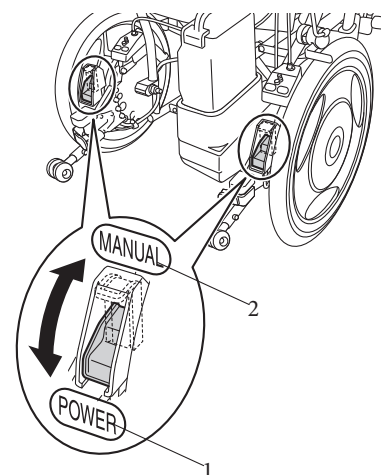
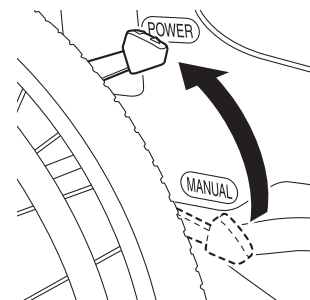

#### WARNING

Surface temperatures can increase when exposed to external sources of heat. (e.g. sunlight)



**! WARNING**

Get into the wheelchair in a level and stable location. If you park the wheelchair on an incline and try to get into it from there, you may lose your balance and fall out.

When operating the E-Drive PLUS 16", have the assistant shift the left and right clutch levers. Even if there is no assistant, the individual in the wheelchair should still not shift the clutch levers.

If you get into the wheelchair when the left and right clutch levers are in the manual position and the parking brakes are released, the wheelchair may move unexpectedly, causing you to fall out and injure yourself. When getting into the wheelchair, make sure that the left and right clutch levers are in the power drive position and the parking brakes are applied.

When switching the clutch levers to the manual position, apply the parking brakes in a level and stable location and have the assistant do so when the power is turned off.

If you are using a wheelchair with no parking brakes, have the assistant hold the wheelchair to ensure that it doesn't move when you are getting into it. If you are getting into a wheelchair with no parking brakes when alone, the wheelchair may move unexpectedly, causing you to injure yourself or those around you.

Do not ride the wheelchair while a USB device is connected to the USB power port.

Otherwise, the controller might be damaged if the wheelchair bumps into an object.

Also, a cable connected to the USB device might become coiled around the joystick, the clutch lever, or a rear tire, possibly causing an accident.

**TIP**

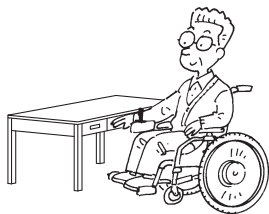

If the controller is in the way when you get in the wheelchair or sit at a table in the wheelchair:

E-Drive PLUS

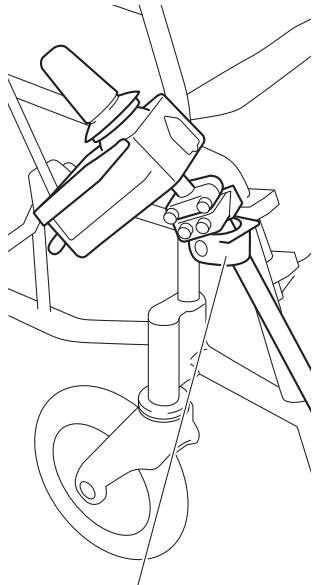

Remove the controller and stow it on the lower holder.

For details, refer to pages 79 and 80.

JW Active PLUS

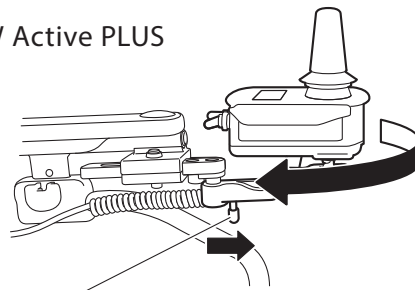

Push the knob forward to turn the controller.

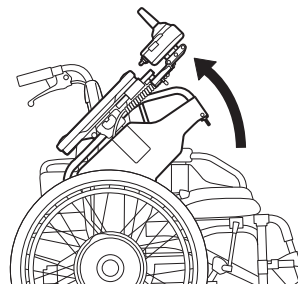

Lift the arm support.

## 4.2. Moving the Wheelchair

- (1) Turn on the power switch (yellow).

When the power to the wheelchair is turned on, all the lamps on the controller illuminate. Then, after 1 second, the “retracted anti-tip device” warning lamp turns off, and the battery residual capacity indicator indicates the battery level.



“Retracted anti-tip device”  
warning lamp

After 1  
second  
→



Battery residual  
capacity indicator



Battery residual capacity indicator

Fully charged



Battery residual  
capacity warning

Empty

Battery residual capacity warning:

When the battery residual capacity becomes less than 10%, the residual capacity lamp flashes, and a short buzzer beeps “Pi Pi Pi Pi” 4 times.

4

- (2) If necessary, adjust the maximum speed.

For the adjustment method, refer to 4.3. Adjusting and Confirming the Maximum Speed.

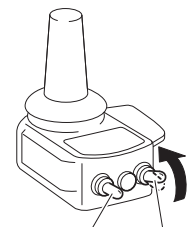

Speed selector  
switch (black)

Power switch (yel-  
low)

- (3) Release the parking brakes.

- (4) The wheelchair starts moving with you tilt the joystick to the desired direction.

Make sure that the joystick returns to its neutral position and the wheelchair stops properly when you release the joystick.

For beginners, refer to pages 47 and 48, and practice the basic operations until you become familiar with them.

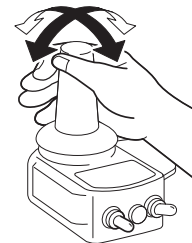

**TIP** If the power does not turn on

Is the power for the assistant controller turned on?

If the power for the assistant controller is turned on, the power for the controller will not turn on.

In this case, turn off the power switches on both controllers, and turn on the power for the controller.

**TIP** If the buzzer sounds and the wheelchair does not move

- (a) Was the power turned on with the joystick tilted?

When you turn on the power switch with the joystick tilted, a safety device is engaged to prevent the wheelchair from moving.

In this case, a buzzer beeps (a long “Pi—” sound) and the power lamp (green) flashes.

Release the joystick, turn off the power, and then turn it back on again.

- (b) Are you tilting the joystick with the left and right clutches in the manual position?

This is a buzzer to warn you that the clutch has been disengaged. (Beeps “Pi Pi, Pi Pi, Pi Pi”)

Turn off the power, switch the left and right clutches to the power drive position, and then turn the power back on.

**TIP** If the buzzer beeps while traveling

While traveling, if the load on the motor is too great, a buzzer (long Pi—, Pi—) sounds continuously.

- (a) Is the live load too great?

The maximum load is 125 kg for E-Drive PLUS 24" and 100 kg for E-Drive PLUS 16". Do not exceed the maximum load.

- (b) Are you trying to go up a steep slope?

The practical climbing angle is 6 degrees. Choose a travel route that does not exceed 6 degrees.

## 4.3. Adjusting and Confirming the Maximum Speed

With the speed selector switch, you can adjust and confirm the maximum speed. Move the switch up to increase the speed, and down to decrease it. Perform the following steps to adjust the maximum speed.

- (1) Move the speed selector switch to change the speed.

Hold the switch up to move the lamp up continuously towards high-speed.

To decrease the maximum speed, perform the same steps in reverse direction.

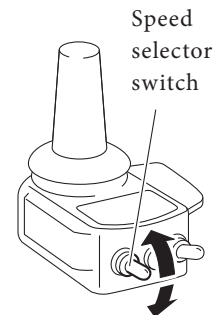

Speed is adjustable in five steps

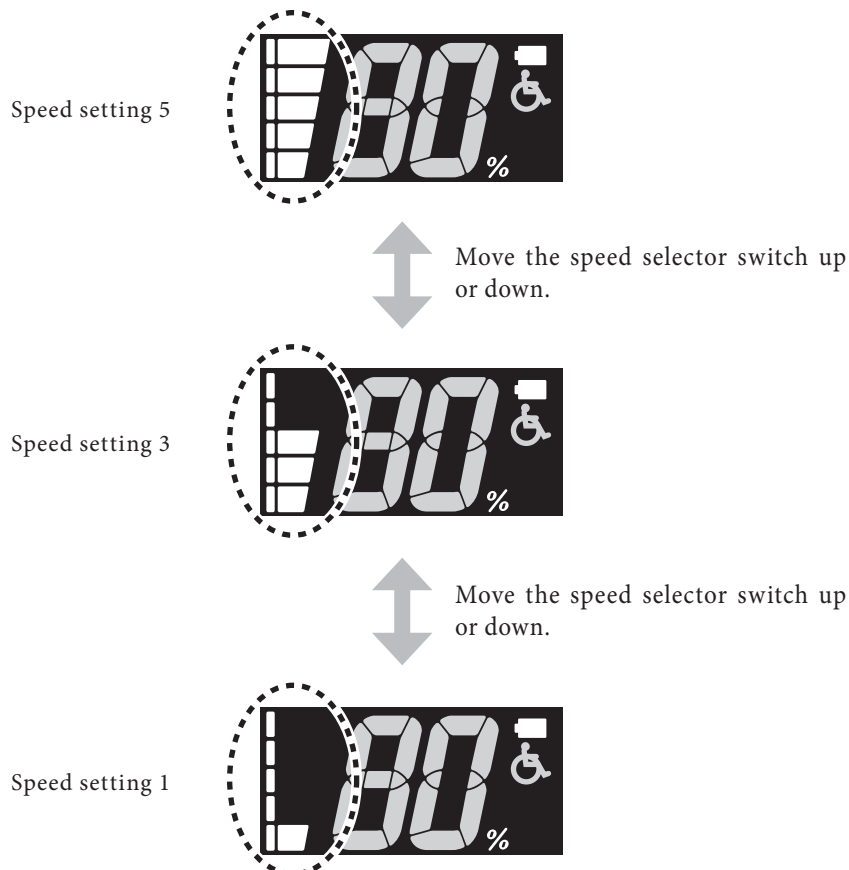

## 4.4. Checking the Residual Capacity of the Battery during Operation

You can always check the residual capacity of the battery with the LCD of the controller.



Battery residual capacity indication

### (1) Battery residual capacity indication

The battery residual capacity indication varies according to the battery type.

For the nickel metal hydride battery and lithium ion battery (gray case), the battery residual capacity is indicated in increments of 20%. For the lithium ion battery (black case), the battery residual capacity is indicated in increments of 10% from 80% to 50% and in increments of 5% from 50%.

Nickel metal hydride battery and lithium ion battery (gray case)



Lithium ion battery (black case)



### (2) Battery residual capacity warning

When the battery residual capacity becomes less than 10%, the residual capacity indication flashes, and a short buzzer beeps “Pi Pi Pi Pi” 4 times.

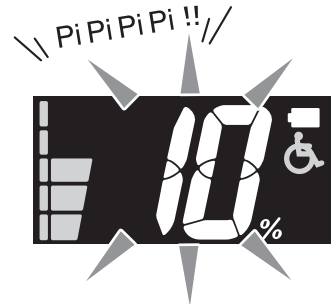

- (3) Once the battery runs out, the residual capacity indication changes to “E” and flashes, a long buzzer beeps “Pi—” once and stops.



### WARNING

When the buzzer beeps to indicate the battery residual capacity warning, promptly move to a safe place, turn off power and charge the battery, or replace with a spare battery (sold separately). It is dangerous when you get into a situation where you cannot move, such as when crossing a road.

## 4.5. Other Functions

---

(1) Using the horn

When you push the horn switch on the controller, the horn sounds.

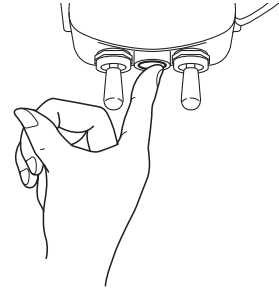

(2) Auto power off function

With the power turned on, if the joystick is not operated for 10 minutes, the power turns off automatically.

To resume operation, turn the power switch off and then back on.

## 4.6. Practicing Basic Operations

(1) Practice the basic operations on a safe, large, level ground.

### Basic Operations 1

1 In the beginning, adjust the maximum speed to a slow speed and learn how to use the joystick.

- Tilt the joystick in the direction you want to go.
- Move the joystick slowly.



2 With the maximum speed set to a slow speed, learn the feel of joystick operation.

- To go slowly, tilt the joystick slightly.
- To go fast, tilt the joystick further.
- To stop, move the joystick back to original position.
- When you take your hand off the joystick, the joystick returns to the original position, and the wheelchair stops.

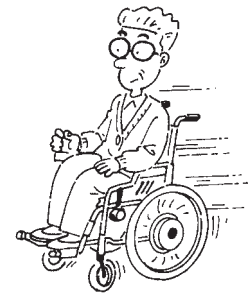

3 Try moving in the following manners.

#### Forward and stop



#### Backwards

- Familiarize yourself with the handling and performance characteristics of backward travel.
- Check behind you for safety.



#### Turns

- Make turns on a single spot.
- Practice turning right and left.

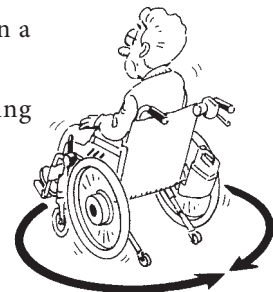

#### S-shaped curves

- Practice until you can travel in the desired direction.
- Learn the feel of speed and timing when making turns.

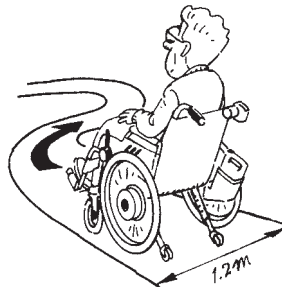

#### Avoid obstructions

- Practice avoiding obstructions.
- Stop before reaching the obstruction.



4 Adjust the maximum speed to medium and fast speeds, and practice in the same way.

### NOTICE

If there is an assistant, use caution to prevent colliding into him or her when moving backward.

(2) Practice in an actual location where you intend to use the wheelchair.

### Basic Operations 2

#### 1 Sidewalk

- Be careful not to bump into pedestrians and obstructions.
- Adjust your operation to suit the road surface conditions.

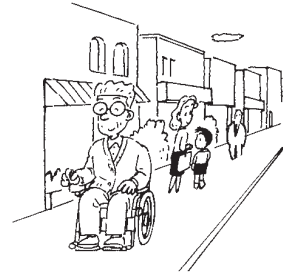

#### 2 Up and down a level difference

- Learn how to safely maneuver up and down a curb and know the limits.
- Stop your wheelchair before a curb, and then proceed carefully.

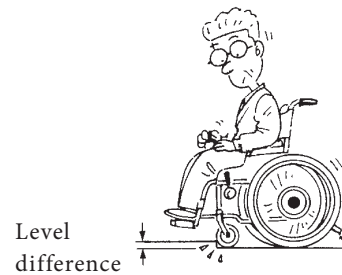

#### 3 Crosswalk

- Allow sufficient time to cross the road at a crosswalk.
- Be careful with the curb between the road and the sidewalk.

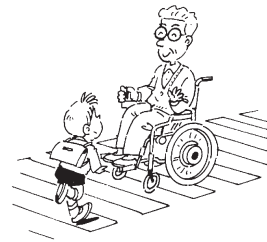

#### 4 Slope

- Get the feel of riding up and down a slope.
- Restart carefully on an uphill.



#### 5 Automatic door

- Practice at the proper stopping position.

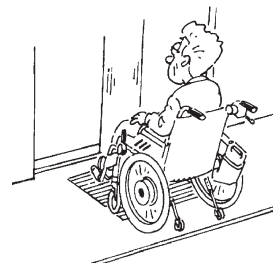

**TIP** Check the condition of the road you frequently use on wheelchair on a daily basis.

Is there a large level difference, steep slope, or rough road?

Try to travel on a route that does not pass through such dangerous locations.



## 5. After You are Finished Riding the Wheelchair

### 5.1. Getting Out of the Wheelchair

- (1) Park the wheelchair on a flat location.
- (2) Turn off the power switch.

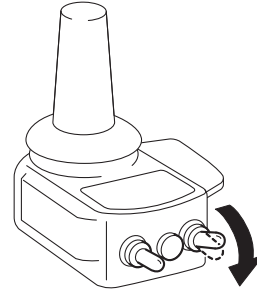

- (3) Apply the parking brakes.  
  
(The left and right clutch levers should be in the power drive position.)
- (4) Get off the wheelchair onto a bed, etc.

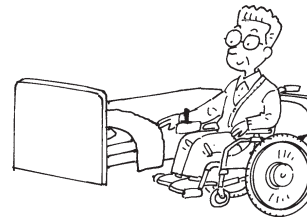

#### WARNING

After you are done traveling in power driver mode, be sure to turn the power off. If the power is on when you get off the wheelchair, your body may hit against the joystick, causing it to start moving, and you or other people in your surrounding may get injured. Get off the wheelchair in a level and stable location. If you park the wheelchair on an incline and try to get off it from there onto a bed or a chair, you may lose your balance and fall off the wheelchair. If you get off the wheelchair with the left and right clutch levers in the manual position and the parking brakes released, the wheelchair may move unexpectedly, causing you to fall off and injure yourself. When getting off the wheelchair, make sure that the left and right clutch levers are in the power drive position and the parking brakes are applied.

## 5.2. Removing the Battery

Disconnect the battery from the wheelchair.  
Store the battery with the protective cap on it.

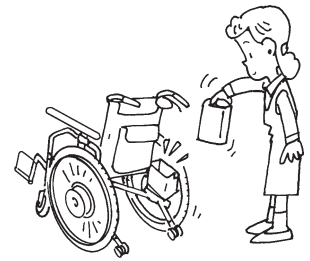

### <How to remove a nickel metal hydride (Ni-MH) battery>

Turn off the power switch.

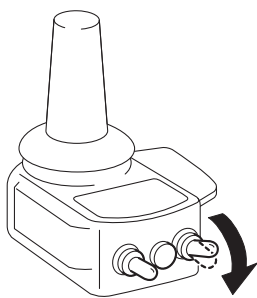

Disconnect the battery by pulling it straight outwards while pressing the release button.

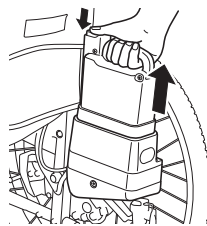

Store the battery with the protective cap on it.



Protective cap

### <How to remove a lithium ion (Li-ion 00) battery>

Turn off the power switch.

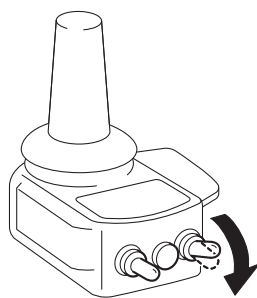

- 1 Stand the grip upright.
- 2 Disconnect the battery by pulling it straight outwards. (Do not pull it out on an angle.)

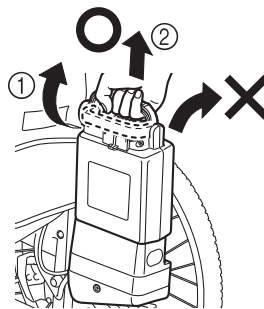

Store the battery with the protective cap on it.

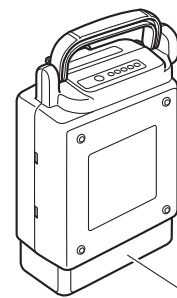

Protective cap

5



### WARNING

Be sure to store the disconnected battery with the protective cap on it. Exposed contacts can cause short circuits and lead to a fire or battery rupture.

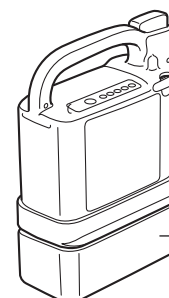

Protective cap

# 6. How to Use the Assistant Controller

Even if you are using the wheelchair with assistive operation, read “3. Before Sitting in the Wheelchair”, “4. Riding the Wheelchair”, “5. After You are Finished Riding the Wheelchair”.

## 6.1. Getting in the Wheelchair

Have the user get in the wheelchair according to “4.1. Sitting in the Wheelchair”.

## 6.2. Starting Assistant Travel Mode

- (1) Switch the left and right clutches to the power drive position.

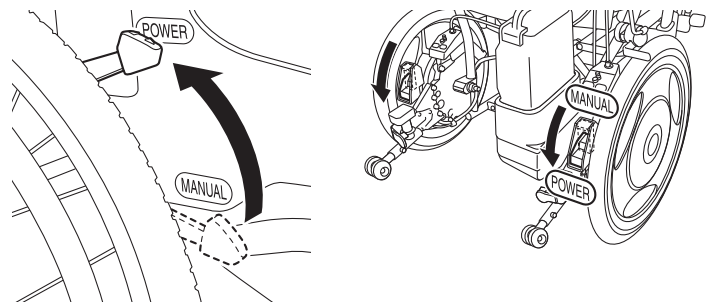

- (2) Turn on the power for the assistant controller.

When you turn on the power, the lamp display changes as shown in the lower-right figure.

When you turn on the power switch, if the battery residual capacity is less than 10%, the warning lamp flashes, and a buzzer beeps “Pi Pi Pi Pi” 4 times. Charge the battery at your earliest convenience.

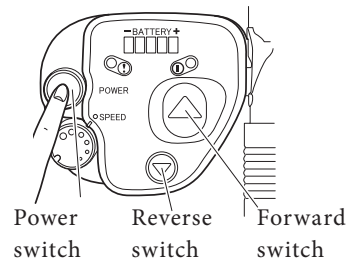

The battery residual capacity lamp indicates the current battery residual capacity.

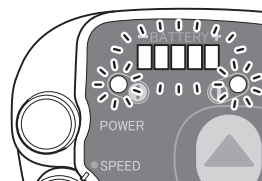

All lamps turn on.

After 1 second

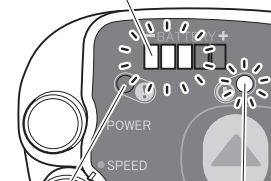

The warning lamp (red) turns off.

The power lamp (green) stays lit.



- (3) Adjust the speed as necessary.

Turn the speed adjustment dial clockwise to increase speed, and counter-clockwise to decrease speed.

In the beginning, adjust it to a low speed. Gradually adjust the speed after you become accustomed to the operation.

The speed can be adjusted steplessly within the range of 1.1 to 4.9 km/h forward and 0.4 to 1.9 km/h backward.

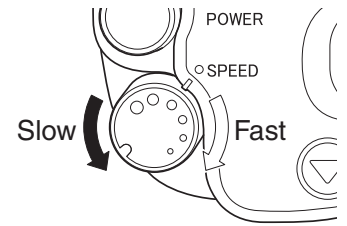

- (4) Release the parking brakes.

- (5) Push the Forward (or Reverse) switch to start moving.

Releasing the Forward (or Reverse) switch stops the wheelchair.

Securely grip the handgrips.

To change the direction of motion or to turn around, operate using the “handgrips”.

To change the position and angle of the assistant controller, refer to page 93.

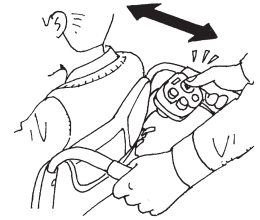

## Basic Operations

To change the direction of movement or to turn.

- Operate with the handgrips.



To descend a slope

- Descend in reverse to avoid the risk of plunging forward.



Perform the following operations after turning off the power and switching the clutches to the manual position.

Getting up a curb

- Move the wheelchair close to a curb at a right angle, and then, while gently stepping on the tipping plate on the anti-tip device as if pushing it forward, pull the “handgrips” down and rearward to raise the casters.

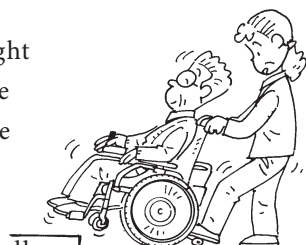

Getting up a high curb

- Turn off the power switch, and stow the anti-tip device to get up a high curb. After getting up the curb, be sure to lower the safety wheels on the anti-tip device.



**TIP** If the power does not turn on

Is the power for the controller turned on?

If the power for the controller is turned on, the power for the assistant controller will not turn on.

In this case, turn off the power switches on both controllers, and turn on the power for the assistant controller.

**TIP** The battery residual capacity lamp does not turn on

If the warning lamp is lit or flashing, it means that the battery has run out.

If the warning lamp turns on immediately after replacing the battery with a fully charged battery, and the wheelchair does not move, there may be a malfunction in the unit.

Contact your dealer.

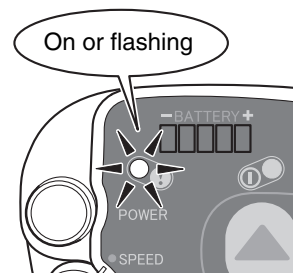

**TIP** If the buzzer sounds and the wheelchair does not move

Are you pushing the operation button with one or both of the left and right clutch levers in the manual position?

This is a buzzer to warn you that the clutch has been disengaged. (Beeps “Pi Pi, Pi Pi, Pi Pi”)  
Turn the power off, switch both of the left and right clutch levers to power drive position, and turn the power back on.

## 6.3. After Assistant Operations are Finished

- (1) Park the wheelchair on a flat location.
- (2) Turn off the power switch.
- (3) Apply the parking brakes.
- (4) Set the left and right clutch levers in the power drive position.
- (5) Have the user get off the wheelchair.
- (6) Disconnect the battery from the wheelchair.  
Store the battery with the protective cap on it.

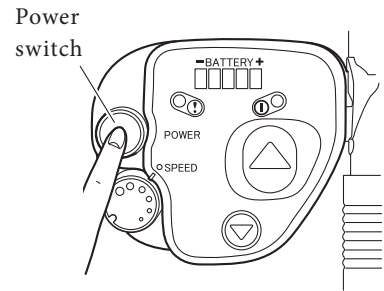

### WARNING

After you are done traveling in assistant power driver mode, be sure to turn the power off. If the power is on when the user get off the wheelchair, the body may hit against the switches, causing it to start moving, and you or other people in your surrounding may get injured. Get off the wheelchair in a level and stable location. If you park the wheelchair on an incline and try to get off it from there onto a bed or a chair, the user may lose the balance and fall off the wheelchair. If the user get off the wheelchair with the left and right clutch levers in the manual position and with the parking brakes released, the wheelchair may move unexpectedly, causing the user to fall off and injure himself/herself. When getting off the wheelchair, make sure that the left and right clutch levers are in the power drive position and the parking brakes are applied.

6

### WARNING

Be sure to store the disconnected battery with the protective cap on it. Exposed contacts can cause short circuits and lead to a fire or battery rupture.

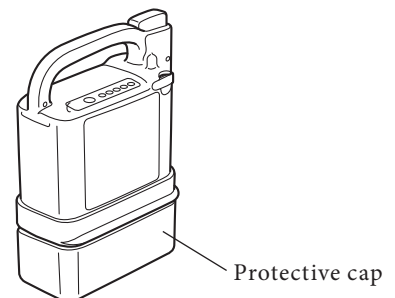

# 7. Handling the Batteries and Chargers

## 7.1. Types of Batteries

There are two types of batteries you can use for E-Drive PLUS.

- Nickel metal hydride battery (JWB2)
- Lithium ion battery (ESB1)

Both types of batteries are sealed dry-cell batteries with a built-in microcomputer. Since the batteries differ in characteristics and charging method, first check the battery type you want to use.

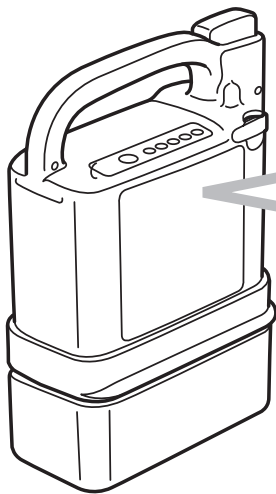

Check the label on the battery.

The label on the nickel metal hydride battery shows **“Ni-MH”**.

The label on the lithium ion battery shows **“Li-ion 00”**.

The nickel metal hydride and lithium ion batteries each come with its own charger.

Read “8. Nickel Metal Hydride Battery and Charger” if you are using a nickel metal hydride battery, and “9. Lithium Ion Battery and Charger” if you are using a lithium ion battery.

### TIP

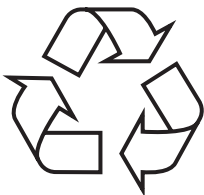

#### Recycling the battery

The battery for E-Drive PLUS is a recyclable battery that contains valuable resources.

Contact the dealer to recycle your used batteries.

## ! WARNING

If you mishandle either of these batteries or their chargers, it may result in heat generation, rupture, electric shock, or injury. Be sure to adhere to the items below.

Do not recharge the battery using a charger other than the designated charger, or use the battery on anything other than the specified wheelchair.

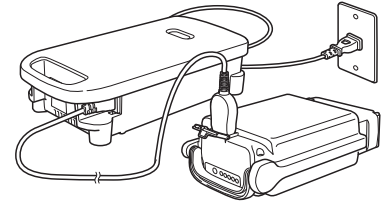
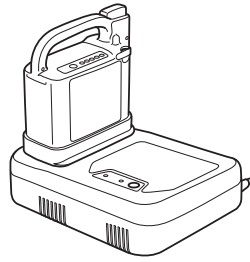

Do not disassemble or modify the battery.

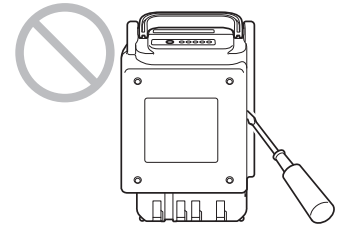
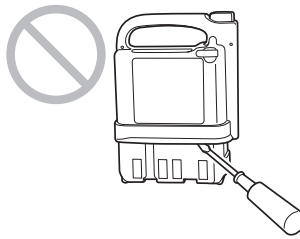

Do not place the battery near an open fire or throw it into a fire.

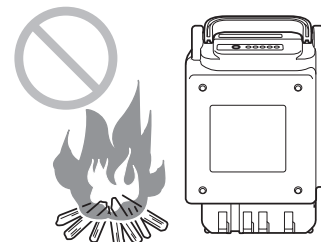

Do not place the battery in water, or splash water on it.

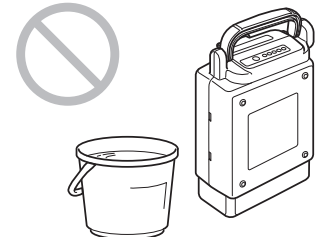

When transporting the wheelchair, in an automobile, for example, remove the battery from the wheelchair.

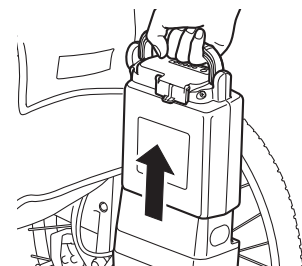
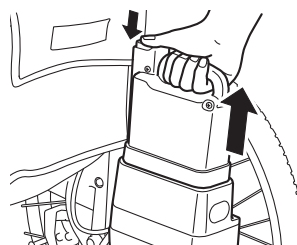

Do not short the terminals of the battery with wires or other metals. Always put on the protective cap when the battery is not in use.



Protective cap

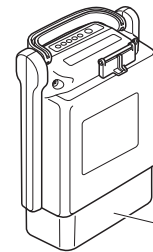

Protective cap



**! WARNING**

If you mishandle either of these batteries or their chargers, it may result in heat generation, rupture, electric shock, or injury. Be sure to adhere to the items below.

Do not store the battery in a place where children or pets could come near it.

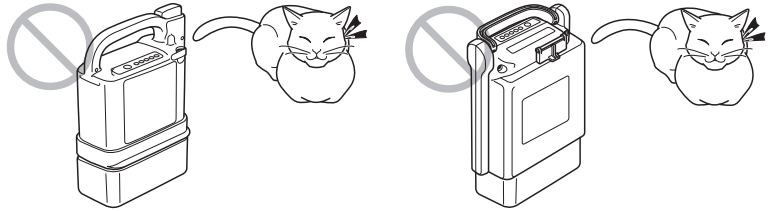

Do not drop or apply impact to the battery.

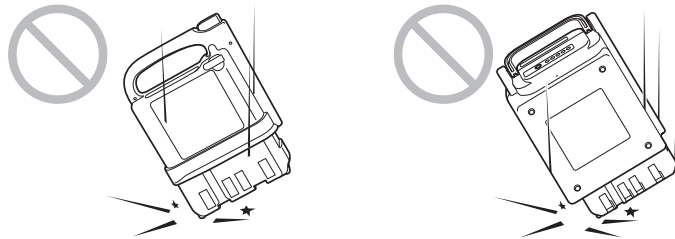

Do not use a broken or damaged battery.

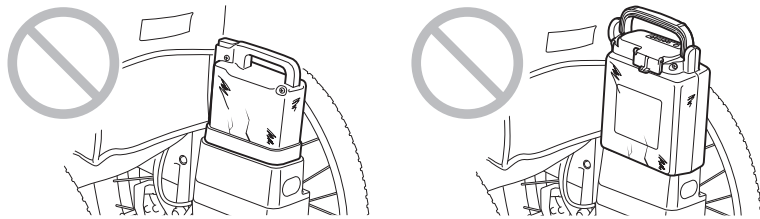

Do not charge the battery in a place where children or pets could come near it.

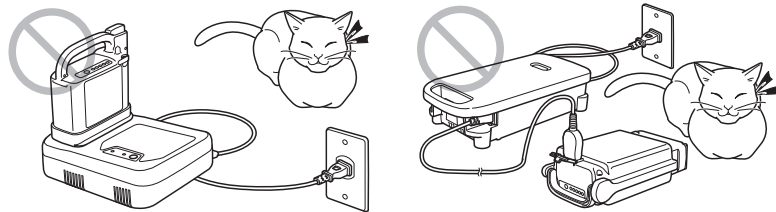

Use the charger on a level surface. After use, do not keep it plugged into the power outlet.

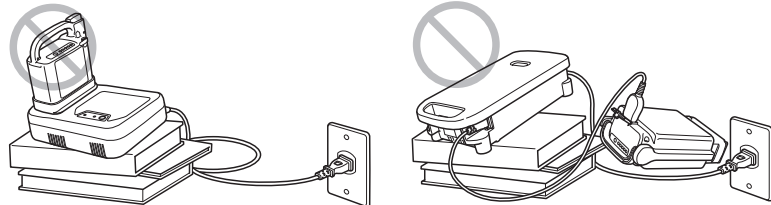

Do not use the charger outdoors or near any flammable object.

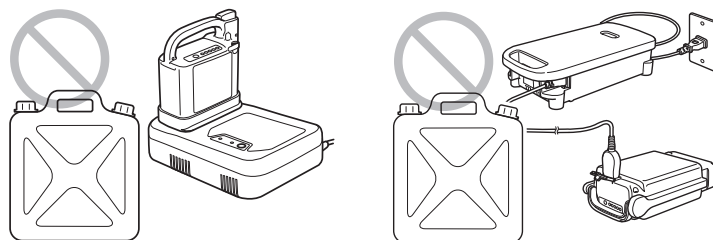

## WARNING

If you mishandle either of these batteries or their chargers, it may result in heat generation, rupture, electric shock, or injury. Be sure to adhere to the items below.

Do not use a damaged cord.

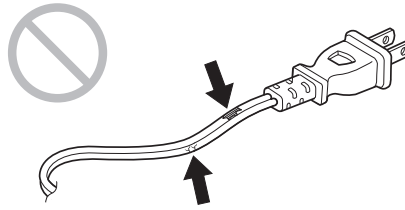

Do not place the charger in water, or splash water on it.

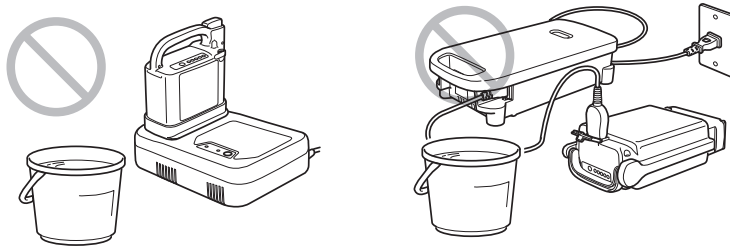

Do not disassemble or modify the charger.

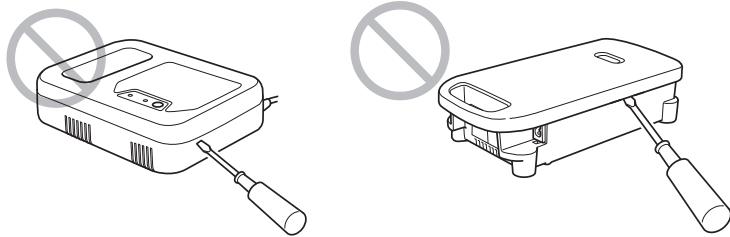

Do not drop or apply impact to the charger.

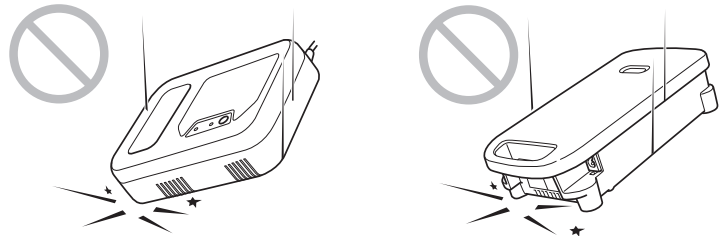

While charging, do not block the intake and exhaust vents of the charger. (When using the nickel metal hydride battery charger [JWC-2])

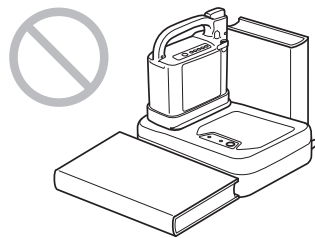

If the battery or the charger is deformed or has an unusual odor, or if you notice any other abnormality, do not use the battery or charger. Contact the dealer.

When inserting or removing the lithium ion battery, be careful not to pinch your finger with the grip. Otherwise, you may injure your finger.

# 8. Nickel Metal Hydride Battery and Charger

## 8.1. Features of the Nickel Metal Hydride Battery (JWB2)

- Equipped with Battery Management Control System (BMC). (built-in microprocessor) This is a system that uses a computer to track charge/discharge status, operating conditions, and temperature.
- An environmentally-friendly battery that does not contain mercury or cadmium.
- Compact but high capacity. (Capacity: 24 V × 6.7 Ah)

## 8.2. How to Use the Nickel Metal Hydride Battery (JWB2)

- (1) Attaching and removing the battery to and from the wheelchair

For instructions on attaching and removing the nickel metal hydride battery to and from the wheelchair, see “4. Riding the Wheelchair” and “5. After You are Finished Riding the Wheelchair”.

- (2) Checking the residual capacity of the battery

Press the indicator switch to display the battery’s residual capacity.

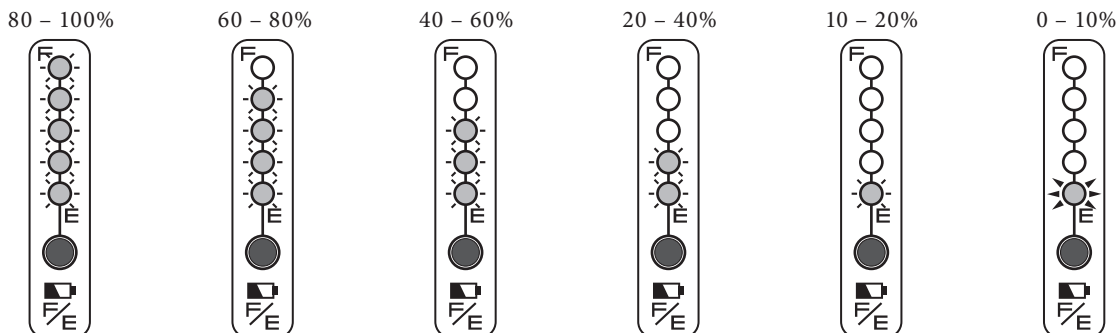
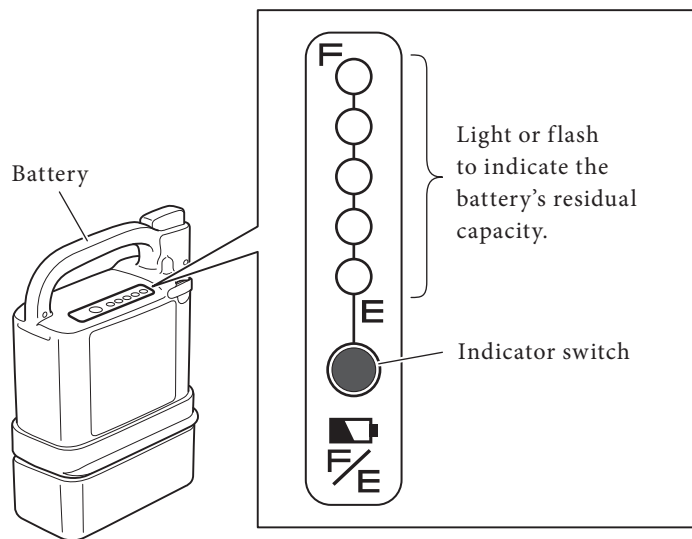

○ : Off

● : On

⊛ : Flashing

### (3) Storing the battery

Store batteries in a cool, dry area. (A location with a temperature between 10°C – 25°C is optimal for storing.)

Fully charge the battery that you do not plan to use for a long period of time (30 days or more).

If you intend to store the battery for more than 3 months without using it, fully charge the battery every 3 months.

Always put on the protective cap when storing the battery.

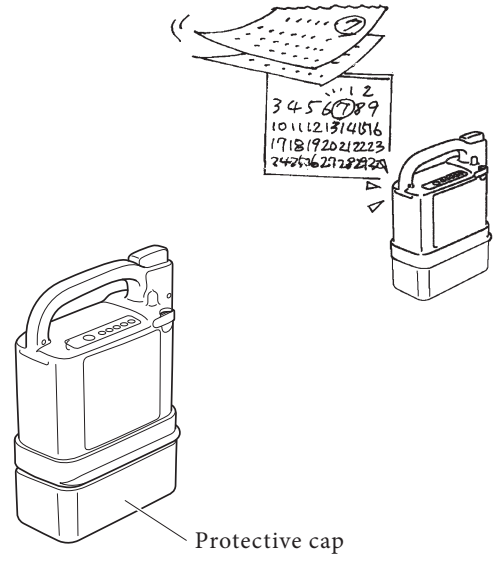

## 8.3. Characteristics and Handling of the Nickel Metal Hydride Battery (JWB2)

### (1) Ambient temperatures

Depending on the ambient temperature, the distance that can be traveled becomes shortened.

In order to maximize the battery's performance, it is recommended that you use the battery under the following conditions.

When in use on the wheelchair:

Temperature range between 0 to 35°C

When removed from wheelchair and stored:

Temperature range between 10 to 25°C

When charging:

Temperature range between 10 to 25°C

- Storing the battery in excessively high or low temperatures will speed up its degradation, and its capacity will rapidly decrease.
- Using the wheelchair in excessively low temperatures will cause the battery capacity to rapidly decrease. For information on degradation, see “Battery’s deterioration characteristics” on the next page.

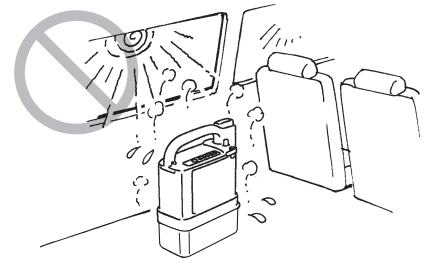

### (2) Memory effect and refresh charging

When a shallow discharging and charging cycle is performed repeatedly on a nickel metal hydride battery, a phenomenon called the memory effect occurs, in which the actual usable capacity decreases.

The memory effect can be prevented and eliminated by fully discharging the battery and then recharging (refresh charging).

If refresh charging is necessary, the microcomputer in the battery sends the information to the charger and the refresh lamp on the charger flashes.

When recharging, if the refresh lamp on the charger flashes, press the refresh switch to perform a refresh charge cycle.

Refresh charging takes longer than normal charging.

For details on refresh charging, refer to “8.5. Refresh Charging the Nickel Metal Hydride Battery (JWB2)”.

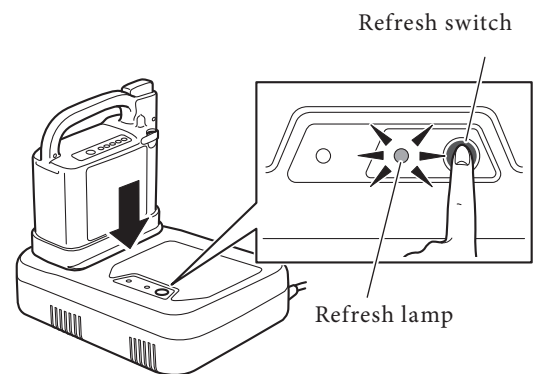

### (3) Battery's deterioration characteristics

All batteries are consumables. A battery gradually deteriorates and its capacity decreases over time and with use.

The extent to which the capacity decreases by deterioration depends on the use conditions.

**TIP** For a nickel metal hydride battery, its capacity will decrease to approximately 60% of that of a new battery after 300 charge/discharge cycles, under normal use.

Even if a battery is not used, when it is stored over a long period of time, its capacity will decrease. When you are using multiple batteries, alternate between the batteries.

The extent of the deterioration of a nickel metal hydride battery can be checked after charging is done, by pushing the indicator switch.

8

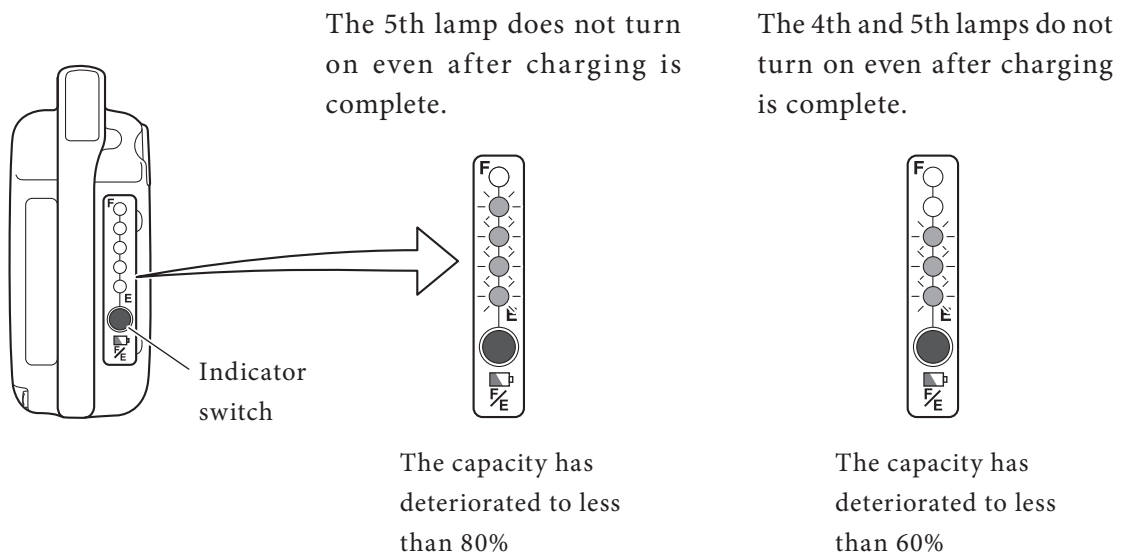

## 8.4. How to Charge the Nickel Metal Hydride Battery (JWB2)

### (1) Charging time

Charging time: 2.5 – 3 hours (when charging the battery from an empty state)

Refresh charging time: 3 – 13 hours (the actual time varies depending on the residual capacity of the battery)

### (2) Charging

- 1 Insert the charger plug into the dedicated charger (JWC-2) and insert the power plug into the residential power outlet.

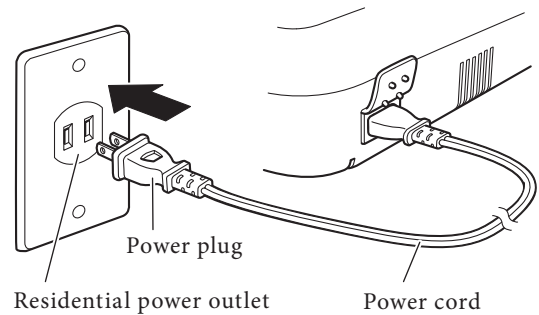
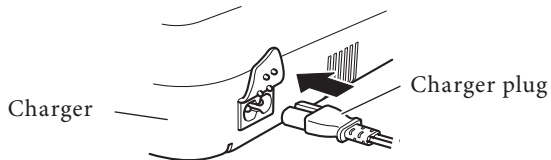

- 2 Insert the battery into the charger as shown in the diagram.

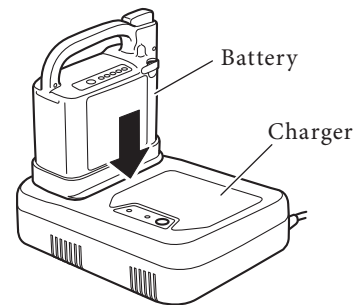

- 3 The charge lamp (green) on the charger turns on, and the battery starts charging. The capacity indicator lamps on the battery flash, and the number of lamps that are lit increases according to the charging level.

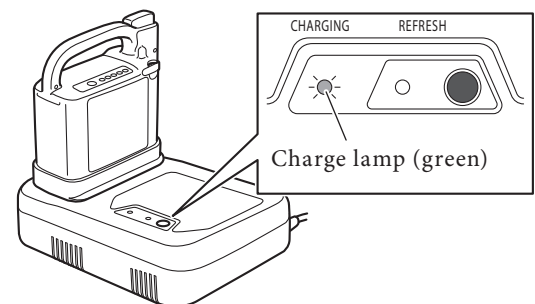

If the charge lamp (green) does not turn on, and the refresh lamp (orange) flashes, refer to “8.5. Refresh Charging the Nickel Metal Hydride Battery (JWB2)”.

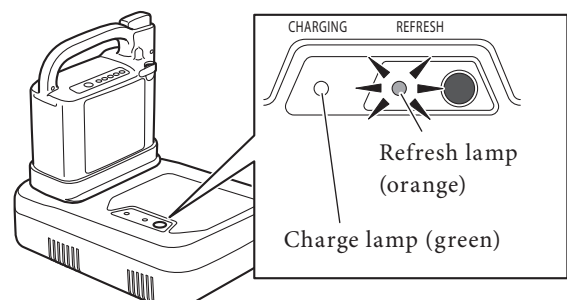

**TIP** Assuming the charging process started from an empty state, the time it takes from start to completion of the charging process is typically 2.5 to 3 hours.

If charging in a location with a high temperature or if charging a brand new battery, this may take longer.

4 Check to ensure that charging is complete.

When charging is complete, the battery capacity indicator lamps and the charge lamp (green) on the charger turn off.

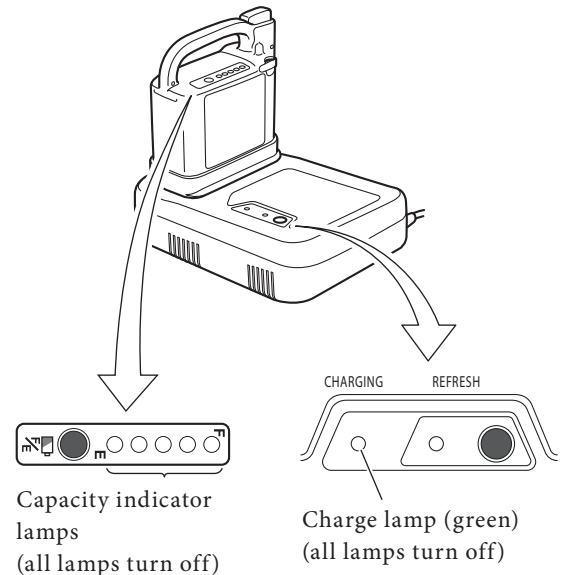

After charging is complete, you can check the charged capacity by pressing the battery indicator switch.

If not all of the lamps turn on, the following could have occurred:

- While charging, the temperature of the battery rose excessively, causing the protection mechanism to abort the charging process.
  - The battery deterioration has advanced and the capacity is decreasing.
- and so on.

5 Unplug the power cord from the power outlet.

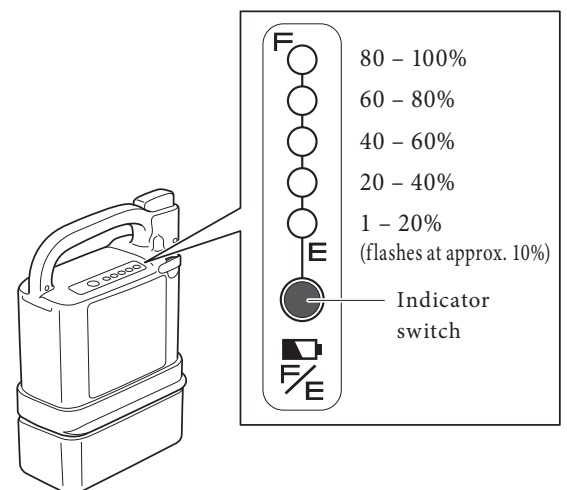

**NOTICE**

Do not pull on the power cord. This can cause the wires to break.

6 Remove the battery from the charger.

If you want to store the battery in this state, put the protective cap on.

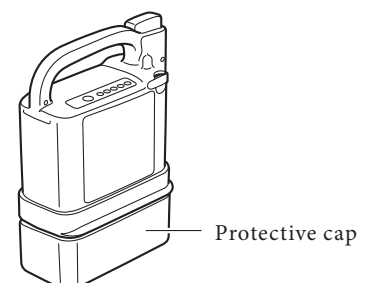



## WARNING

Be sure to store the disconnected battery with the protective cap on it. Exposed contacts can cause short circuits and lead to a fire or battery rupture.

### TIP If you are unable to charge the battery

Refer to “14. Troubleshooting”.

### (3) Suitable temperature for charging

Charge the battery in an environment with a temperature of 10 to 25°C.

- To protect the battery, if the internal temperature of the battery is under 0°C or over 40°C, charging does not start. Instead, it enters a standby mode. During this time, the charge lamp (green) flashes.

While in standby mode, when the battery reaches an appropriate temperature, the charge lamp will change from a flashing to an “on” state, and charging will start automatically. (The length of the standby time varies with conditions.)

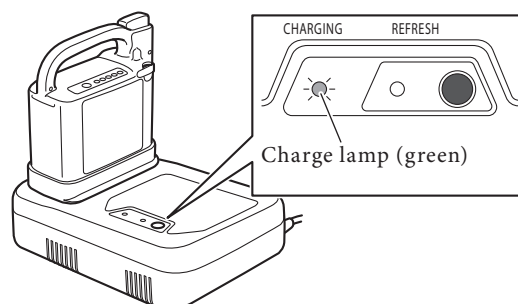
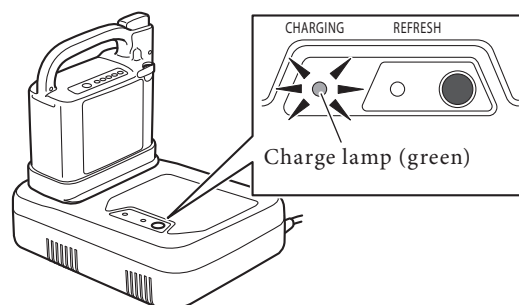

- The battery temperature increases during charging. However, if the battery temperature rises above 50°C, the power for the charger will turn off to protect the battery. Since charging has not ended, it is necessary to charge again after the battery temperature has decreased. Charging a battery immediately after travel, or charging a new battery is likely to cause its temperature to increase, which increases the likelihood of the charger stopping charging before completion.
- A cooling fan operates automatically if the charger temperature increases during charging. While charging, do not block the intake and exhaust vents of the charger.

## 8.5. Refresh Charging the Nickel Metal Hydride Battery (JWB2)

A refresh charging is required on a nickel metal hydride battery to eliminate the memory effect. When the battery is inserted to the charger, if the refresh lamp (orange) on the charger flashes, press the refresh switch to perform a refresh charge cycle. (The refresh lamp flashes after every 20 to 30 charge cycles. If the refresh lamp does not flash, it is not necessary to perform a refresh charge cycle.)

- (1) While the refresh lamp (orange) is flashing, press the refresh switch.

\* The refresh lamp (orange) flashes only when refresh charging is needed.

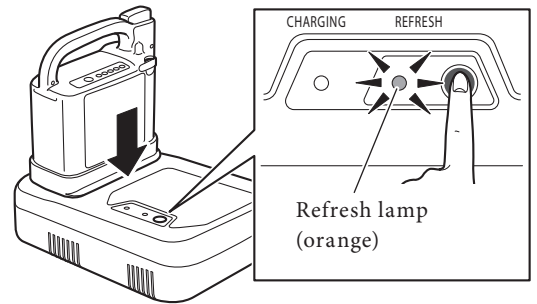

- (2) The refresh lamp (orange) changes from a flashing to an “on” state, and the refresh charging starts.

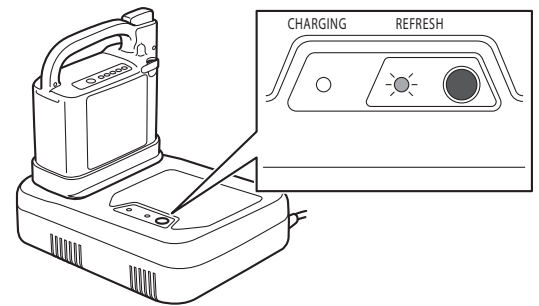

In a refresh charging process, after all remaining electricity has been discharged, the refresh lamp (orange) turns off. The charge lamp (green) lights up and a normal charging process begins. The time it takes from the start of refresh charging to the completion of normal charging is 3 – 13 hours.

- If the temperature of the battery rises during a refresh charge, the charge lamp (green) may flash and the charging process may pause. When the battery reaches an appropriate temperature, the charge lamp will change from a flashing to an “on” state and charging will start automatically.
- If you perform a refresh recharge when the internal temperature of the battery is under 0°C or over 40°C, it may enter a standby mode as it goes into normal charging after discharging the remaining electricity.
- Even if you fail to press the refresh switch, you can retry by momentarily removing the battery from the charger, and then reinserting the battery to see the refresh charging alert.
- If you do not press the refresh switch while the refresh lamp (orange) is flashing, the flashing refresh lamp will turn off after 1 minute. Then the charge lamp lights up and a normal charging process begins. In this case, the refresh lamp flashes again the next time you charge the battery.

**TIP** Tips on charging

- It is recommended that you charge the battery while you are sleeping.
- Since the refresh charging process recharges after discharging all of its remaining electricity, it will take a long time if you perform it on a battery with a high residual capacity. It is recommended that you perform a refresh charging on a battery that is drained as much as possible.

## 8.6. Charger (JWC-2) Indicator Lamps

The charger (JWC-2) for the nickel metal hydride battery has two types of lamps: the charge lamp (green) and refresh lamp (orange). Each lamp comes on or flashes to indicate the battery and charging conditions. The lamp indications are explained in the following table.

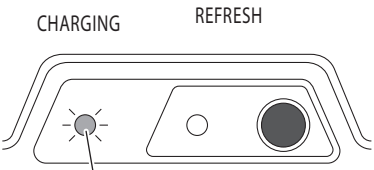
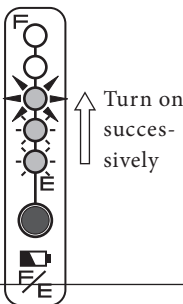
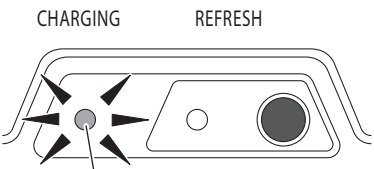
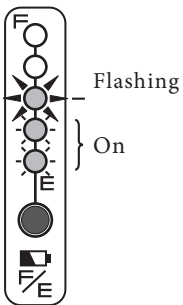
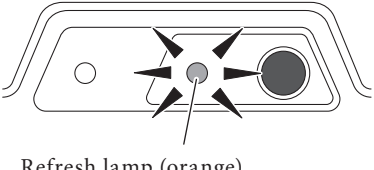
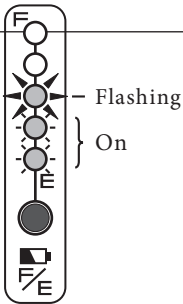
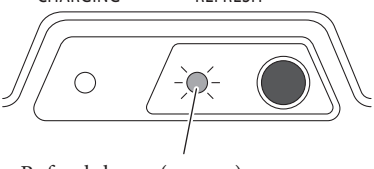
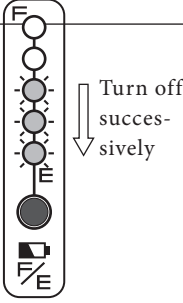
Charger lamp indication	Battery capacity indicator lamps	Description
<p>Charge lamp (green) is on</p>  <p>Charge lamp (green)</p>	 <p>Turn on successively</p>	<p>Indicates normal charging.</p> <p>The charge lamp will turn off after charging is completed.</p>
<p>Charge lamp (green) is flashing</p>  <p>Charge lamp (green)</p>	 <p>Flashing On</p>	<p>Indicates charge standby.</p> <ul style="list-style-type: none"> <li>When the temperature of the battery is not within the chargeable range (0 to 40°C), the charger enters a standby state and the charge lamp (green) starts flashing.</li> <li>Once the battery temperature falls within the chargeable range during standby, charging will start automatically and the charge lamp (green) changes from a flashing to an “on” state. However, if the charge standby condition continues for a long time, charging will end, and the power for the charger will turn off.</li> </ul>
<p>Refresh lamp (orange) is flashing</p>  <p>Refresh lamp (orange)</p>	 <p>Flashing On</p>	<p>Refresh charging is being requested.</p> <p>While the refresh lamp is flashing, press the refresh switch to perform a refresh charge cycle.</p> <p>If you do not press the refresh switch, a normal charging begins after 1 minute.</p>
<p>Refresh lamp (orange) is on</p>  <p>Refresh lamp (orange)</p>	 <p>Turn off successively</p>	<p>Indicates refresh charging.</p> <p>The remaining electricity is being discharged as part of the refresh charging process. When the discharge has completed, normal charging will start.</p>

# 9. Lithium Ion Battery and Charger

## 9.1. Features of the Lithium Ion Battery (ESB1)

- Has a higher energy capacity compared to the nickel metal hydride battery.
- Equipped with Battery Management Control System (BMC). (built-in microprocessor) This is a system that uses a computer to track charge/discharge status, operating conditions, and temperature.
- Even with repeated shallow discharge/charge cycles, it is difficult for the memory effect to occur. Therefore, refresh charging is not necessary, and its charges can be replenished additively.
- An environmentally-friendly battery that does not contain mercury or cadmium.
- Compact but high capacity. (Capacity: 25 V × 11.2 Ah)

## 9.2. How to Use the Lithium Ion Battery (ESB1)

- (1) Attaching and removing the battery to and from the wheelchair

For instructions on attaching and removing the lithium ion battery to and from the wheelchair, see “4. Riding the Wheelchair” and “5. After You are Finished Riding the Wheelchair”

- (2) Checking the residual capacity of the battery

Press the indicator switch to display the battery’s residual capacity.

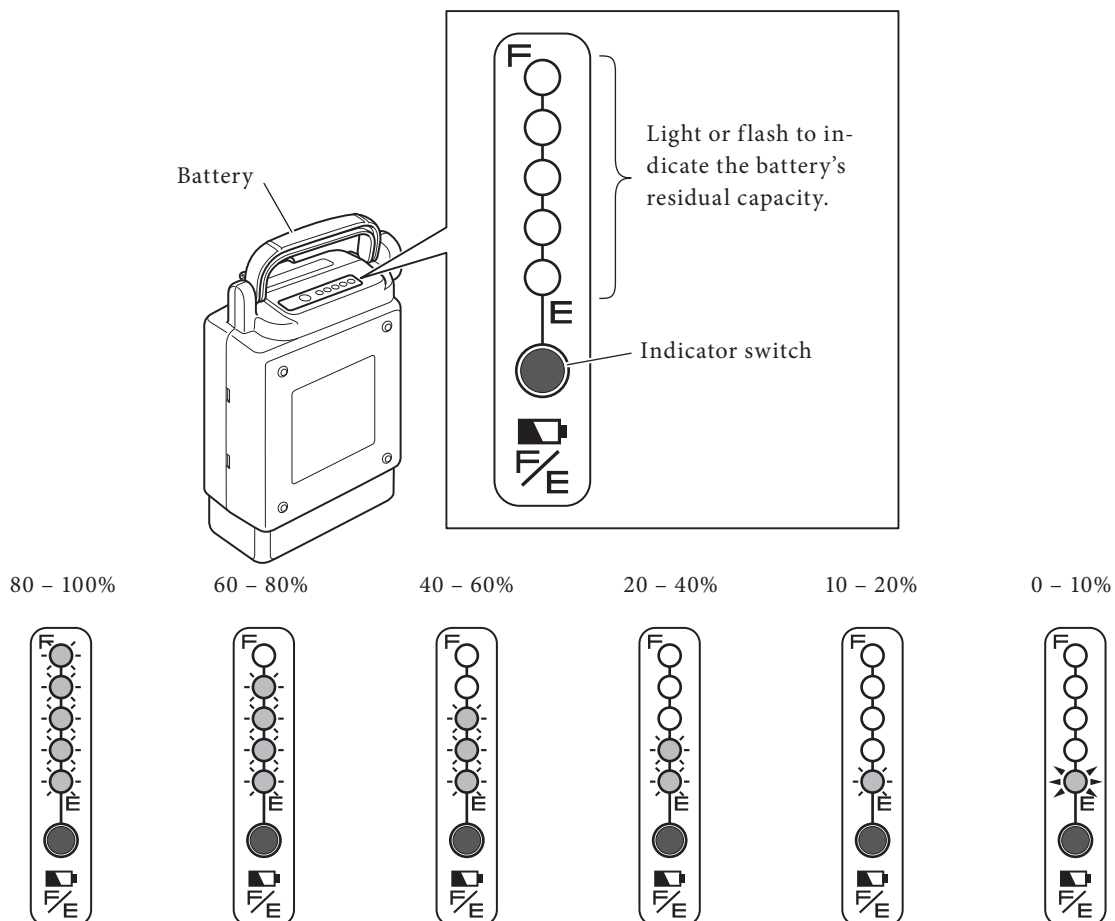

○ : Off

◐ : On

◑ : Flashing

(3) Storing the battery

Store batteries in a cool, dry area. (A location with a temperature between 10°C – 25°C is optimal for storing.)

If you are not planning on using the battery for a long period of time (30 days or more), charge it so that 3 of the capacity indicator lamps light up, and then store it.

To store the battery without using it for over 3 months, check every 3 months to see if 3 capacity indicator lamps light up.

If 2 or less lamps turn on, charge the battery until 3 lamps turn on.

Always put on the protective cap when storing the battery.

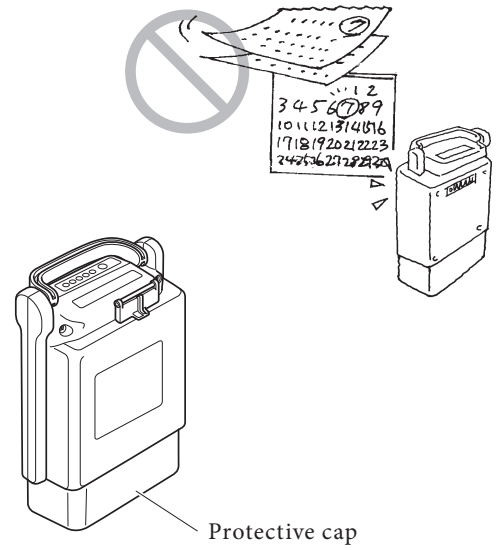

## 9.3. Characteristics and Handling of the Lithium Ion Battery (ESB1)

### (1) Ambient temperatures

Depending on the ambient temperature, the distance that can be traveled becomes shortened.

In order to maximize the battery's performance, it is recommended that you use the battery under the following conditions.

When in use on the wheelchair:

Temperature range between 0 to 35°C

When removed from wheelchair and stored:

Temperature range between 10 to 25°C

When charging:

Temperature range between 10 to 25°C

- Storing the battery in excessively high or low temperatures will speed up its degradation, and its capacity will rapidly decrease.
- Using the wheelchair in excessively low temperatures will cause the battery deterioration to speed up and its capacity to rapidly decrease. For information on degradation, see "Battery's deterioration characteristics" on the next page.



9

**TIP** While traveling, if the internal temperature of the lithium ion battery becomes too high or too low, a buzzer will notify you.

- When using a lithium ion battery, a buzzer will beep (continuous Pi Pi Pi Pi) if the battery's internal temperature drops to 0°C or below, or rises to 45°C or above for 5 seconds.
- When the buzzer beeps, promptly return to the environment within the recommended range of operational temperatures, and use the battery there.
- When descending down a slope on the wheelchair, the drive motor, contrary to normal operation, generates electricity and charges the battery. Charging a lithium ion battery when its temperature is 0°C or below/45°C or above causes its deterioration to progress extremely rapidly. For this reason, when you are descending down a slope in such temperatures, the wheelchair may stop moving to protect the battery.

When this happens, you will hear 5 long beeps before the wheelchair stops, and then another long beep 10 seconds later as the wheelchair stops.

## (2) Battery's deterioration characteristics

All batteries are consumables. A battery gradually deteriorates and its capacity decreases over time and with use.

The extent to which the capacity decreases by deterioration depends on the use conditions.

**TIP** For a lithium ion battery, its capacity will decrease to approximately 60% of that of a new battery after 700 charge cycles, under normal use.

Even if a battery is not used, when it is stored over a long period of time, it will deteriorate and its capacity will decrease.

When you are using multiple batteries, alternate between the batteries.

**TIP** Immediately after the lithium ion battery has successfully completed charging (fully charged), pushing the indicator switch will always show all 5 lamps lit. Even if deterioration has progressed, all 5 lamps should turn on when fully charged. This display format was adopted for this battery, as the rate of deterioration of lithium ion batteries is gradual.

## (3) The life of the lithium ion battery

The life of the lithium ion battery (ESB1) is 8 years from its initial charging, or 8,000 Ah of integral charge capacity.

- Battery life alert

The capacity indicator lamps start alerting you from 3 months prior to the battery becoming no longer chargeable due to its end-of-life, or when the integral charge capacity reaches 7,800 Ah.

When charging has completed and the charger plug is unplugged, the capacity indicator lamps turn on and off as shown in the figure on the right.

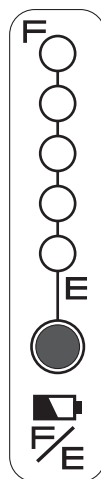

The capacity lamps turn on and off repeatedly for 5 seconds, in the order of the arrows.

- When the battery reaches end of life

Once the battery reaches its end of life, the lamp on the charger will not turn on when attempting to charge the battery. Moreover, the battery's capacity indicator lamps no longer turn on and the battery cannot be charged.



**TIP** If you forget the date you started to use the lithium ion battery.

The battery's manufactured date is printed on its bottom. Use it as a reference.

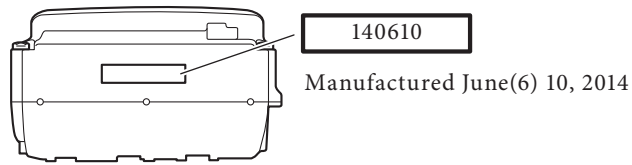

- The start date of battery usage is defined as the date the user charged the battery for the first time after shipment from the factory.  
(This does not match the manufactured date above.)
- Once the integral charge capacity reaches 8,000 Ah, the battery will not be usable even if it has not been 8 years.
  - \* The integral charge capacity of 8,000 Ah is approximately 700 times the capacity of the “ESB1” lithium ion battery (hence equivalent to approximately 700 charge cycles, when fully charged from 0 residual capacity).

## 9.4. How to Charge the Lithium Ion Battery (ESB1)

There are two ways to charge the battery; by removing it from the wheelchair (tabletop charging), or while it is still attached to the wheelchair (on-vehicle charging).

### (1) Charging time

Charging time: Approx. 4.5 hours (when charging the battery from an empty state)

### (2) Charging the battery out of the unit (tabletop charging)

- 1 Check that the protective cap is on the battery.

If the protective cap is not attached, be sure to attach it.

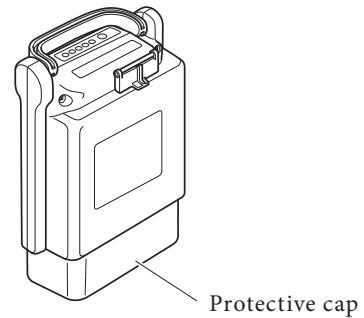

- 2 Insert the power plug of the dedicated charger (ESC1) into the residential power outlet.

- 3 Rest the battery on its side.

- 4 Open the connector cover, and insert the charger plug into the charge connector on the battery.

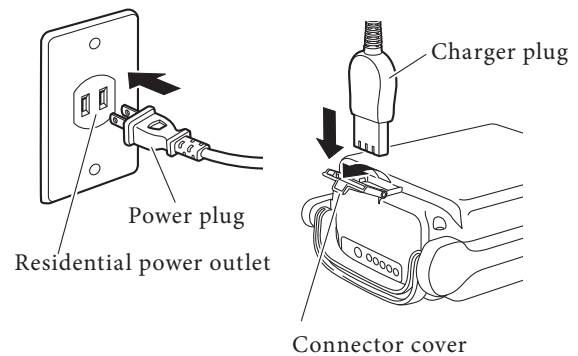

- 5 Check that the charge lamp (green) on the charger turns on.

If the charge lamp does not light green, see “9.6. Charge Lamp Indication”.

- 6 While charging, you can check the charge status using the capacity indicator lamps on the battery.

The capacity indicator lamps will turn off after charging has completed.

Assuming that charging started with the battery in an empty state, the time to completion is typically 4.5 hours.

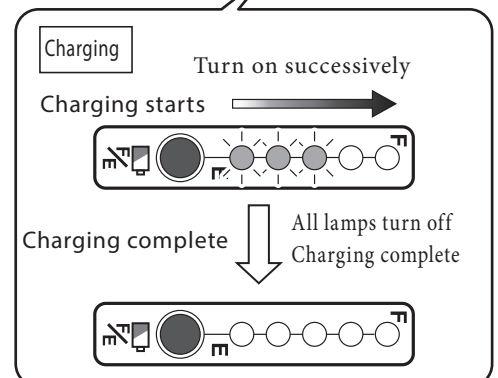
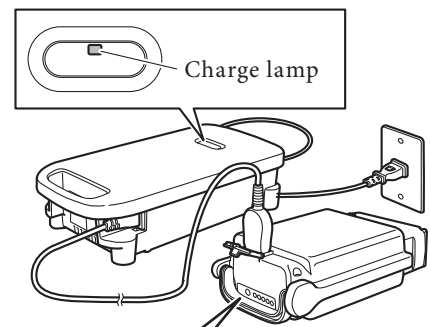

- 7 After charging has completed, unplug the charger plug and the power plug, then securely close the battery's connector cover.

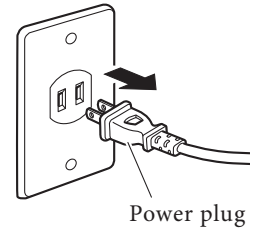
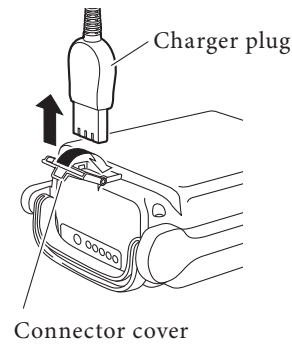

**NOTICE**

Do not pull on the power cord. This can cause the wires to break.

(3) Charging the battery attached to the wheelchair (on-vehicle charging)

- 1 Prepare for charging.

Remove any bags and luggage from the backrest, and anything else that can potentially tangle the charge cable.

Park the wheelchair indoor on a level floor, and apply the parking brakes.

- 2 Turn off the power switch on the wheelchair.

As a safety measure, during on-vehicle charging, the wheelchair will not power on even if it is switched on.

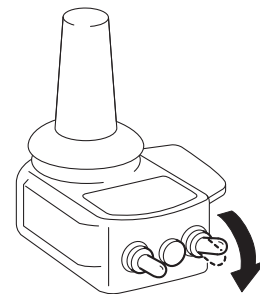

- 3 Insert the power plug of the dedicated charger (ESC1) into the residential power outlet.

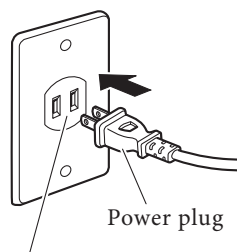

- 4 Open the connector cover, and insert the charger plug into the charge connector on the battery.

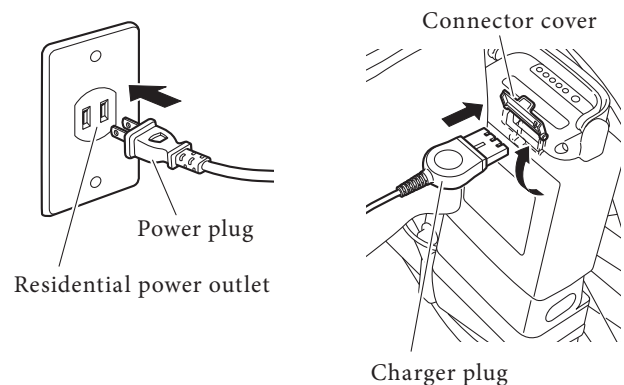

- 5 Check that the charge lamp (green) on the charger turns on.  
If the charge lamp does not light green, see “9.6. Charge Lamp Indication”.

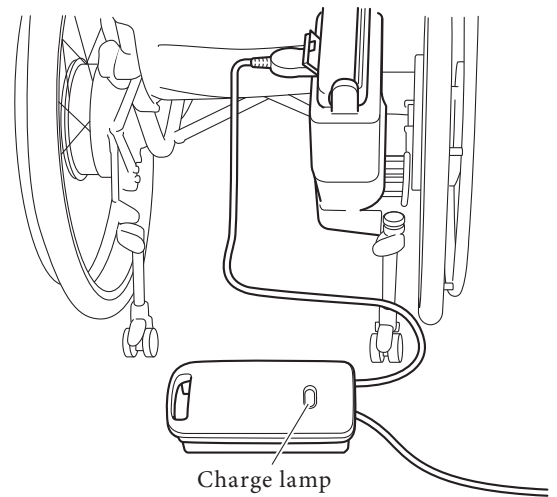

- 6 While charging, you can check the charge status using the capacity indicator lamps on the battery.  
The capacity indicator lamps will turn off after charging has completed.  
Assuming that charging started with the battery in an empty state, the time to completion is typically 4.5 hours.

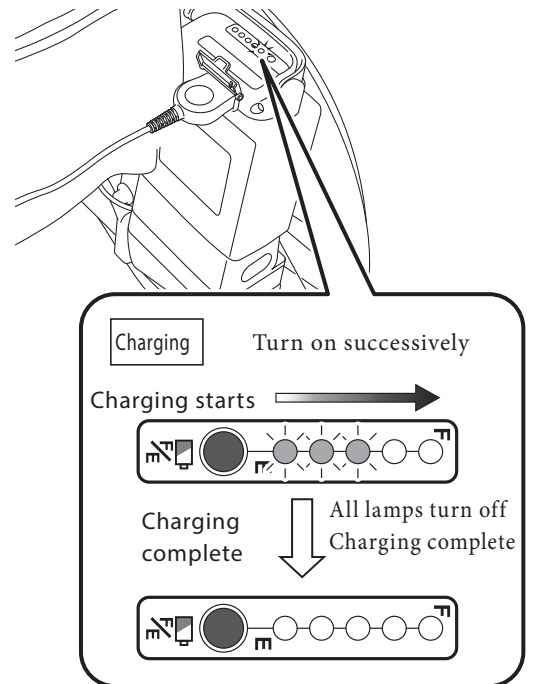

- 7 After charging has completed, unplug the charger plug and the power plug, then securely close the battery's connector cover.

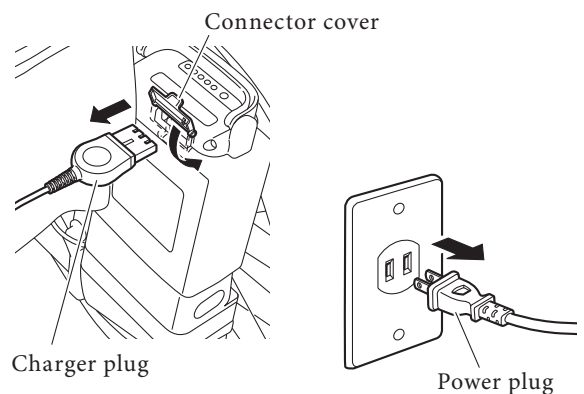

### NOTICE

Do not pull on the power cord. This can cause the wires to break.

## 9.5. The Temperature of the Lithium Ion Battery (ESB1) during Charging

Charge the battery in an environment with a temperature of 10 to 25°C.

- To protect the battery, if the internal temperature of the battery is under 0°C or over 40°C, charging does not start. Instead, it enters a standby mode. During this time, the charge lamp (green) flashes.

While in standby mode, when the battery reaches an appropriate temperature, the charge lamp (green) will change from a flashing to an “on” state, and charging will start automatically. (The length of the standby time varies with the conditions.)

- The battery temperature increases during charging. However, if the battery temperature rises above 45°C, the power for the charger will turn off to protect the battery. Since charging has not ended, it is necessary to charge again after the battery temperature has decreased.

Charging a battery immediately after travel, or charging a new battery is likely to cause its temperature to increase, which increases the likelihood of the charger stopping charging before completion.

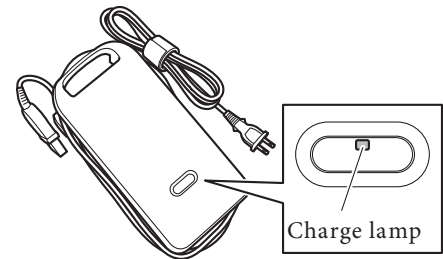

## 9.6. Charge Lamp Indication

The charger (ESC1) for the lithium ion battery has a charge lamp to indicate the battery and charging conditions according to the lamp's color and whether it is on or flashing.

The lamp indications are explained in the following table.

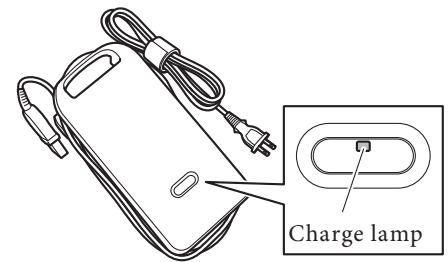

9

Charger lamp indication	Battery capacity indicator lamps	Description
<p>Lit green</p> <p>Charge lamp (green)</p>	<p>Turn on successively</p>	<p>Indicates normal charging. The charge lamp will turn off after charging has completed.</p>
<p>Flashing green</p> <p>Charge lamp (green)</p>	<p>Flashing On</p>	<p>Indicates charge standby.</p> <ul style="list-style-type: none"> <li>When the temperature of the battery is not within the chargeable range (0 to 40°C), the charger enters a standby state and the charge lamp starts flashing in green.</li> <li>Once the battery temperature falls within the chargeable range during standby, charging will start automatically and the charge lamp (green) changes from a flashing to an "on" state. However, if the charge standby condition continues for a long time, charging will end. When this happens, the charge lamp flashes rapidly in green.</li> </ul>
<p>Lit or flashing red</p> <p>Charge lamp (red)</p>	<p>Off</p>	<p>The charger has detected a problem in the charger or the battery, and is unable to charge. Stop charging by disconnecting the charger plug and the power plug. Check the battery, charger, and cord connection for any problem, and then try charging again.</p> <p>If the charge lamp lights or flashes in red again, an equipment failure may have occurred. Stop charging by disconnecting the charger plug and the power plug, and have the equipment inspected by a dealer.</p>

## 10. Wheelchair Transporting and Storing Instructions

Please refer to the Warnings in “1.5.15. Transporting and Storing the Wheelchair” on page 23 to 25.

### 10.1. Loading the Wheelchair in a Car

- (1) Turn off the power of the wheelchair.

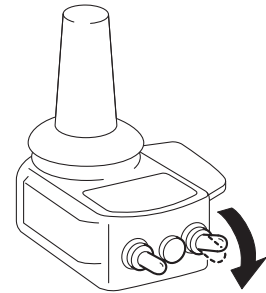

- (2) Remove the battery.  
Be sure to remove the battery from the wheelchair so that its power will not turn on unexpectedly during transport.  
Be sure to put the protective cap on the removed battery.

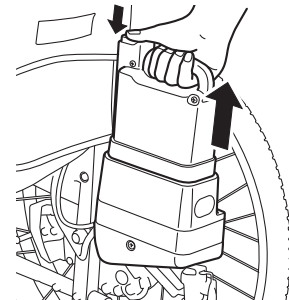

- (3) Lock the wheels.  
Set the left and right clutch levers to the power drive position so that the wheels will not spin, and then apply the parking brakes.
- (4) Remove any detachable parts.  
Remove the foot-leg supports and any other parts that can be detached.
- (5) Detach the drive units.  
If necessary, detach the drive units from wheelchair frame.  
Refer to “11.1. Removing and Installing the Unit” (pages 84 to 87).
- (6) Fold the wheelchair.  
If necessary, fold the wheelchair.

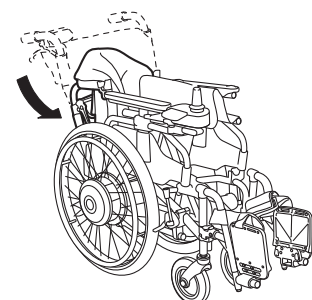

 **WARNING**

Be sure to store the disconnected battery with the protective cap on it. Exposed contacts can cause short circuits and lead to a fire or battery rupture.

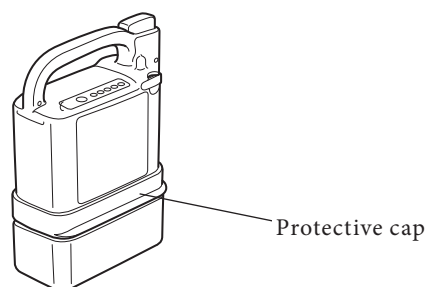

- (7) Load the wheelchair into the car.  
Gently load the wheelchair by holding the frame portion with both hands.

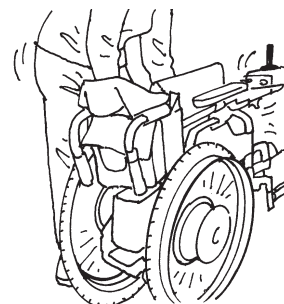

- (8) Secure the wheelchair.  
Secure the wheelchair to prevent it from moving or hitting any surrounding objects.

**TIP** When loading:

- This product uses precision electronic parts. Do not apply sharp impact.
- Load it upright whenever possible.
- If loading it on its side, place it so that the controller is at the top. Secure the wheelchair, ensuring that the controller is not hitting against any surrounding object.

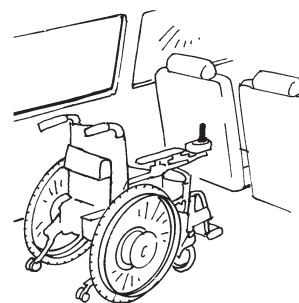

**TIP** Securing the Wheelchair

- Strap it down with a belt, etc., or place a shock absorbing material under and around the wheelchair.

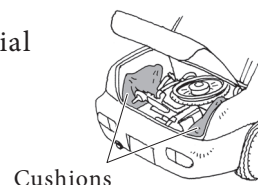



## 10.2. Unloading the Wheelchair from a Car

- (1) Unload the wheelchair from the car.

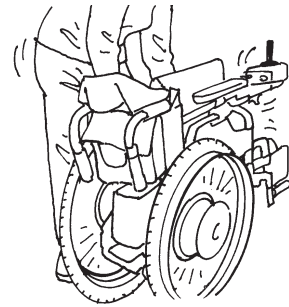

- (2) Reattach the removed parts, detached units back to their original places, and unfold the wheelchair.



- (3) Check that the parking brakes are applied.
- (4) Check that the anti-tip device is in the correct position.



### TIP When unloading:

- This product uses precision electronic parts. Do not apply sharp impact.

### WARNING

If the foot-leg supports are removed or foldable parts are folded, be sure to place them in their original positions before operating the wheelchair. Never operate the wheelchair with parts removed or folded. You may injure yourself.

If the anti-tip device is folded or its safety wheels are facing upwards, be sure to place it in its original position and confirm that it is locked before operating the wheelchair. Never operate the wheelchair with the anti-tip device folded or its safety wheels facing upwards. You may injure yourself.

## 10.3. Storing the Wheelchair

- (1) Apply the parking brakes and set the left and right clutch levers in the power drive position.

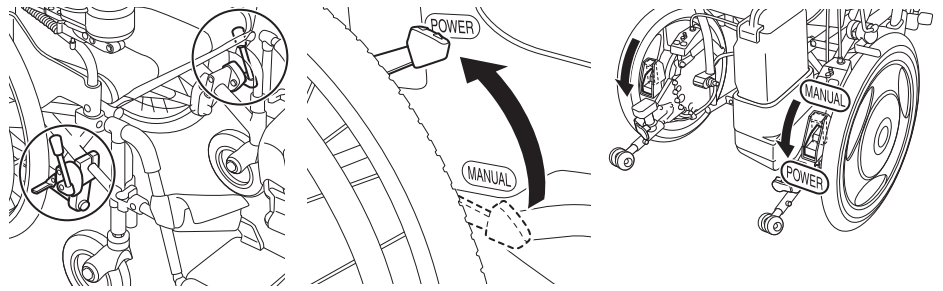

- (2) Turn off the power and remove the battery.

- (3) Store the wheelchair indoors where there is less humidity.

- (4) To wipe off dirt or spots before storing, use a tightly wrung-out towel.

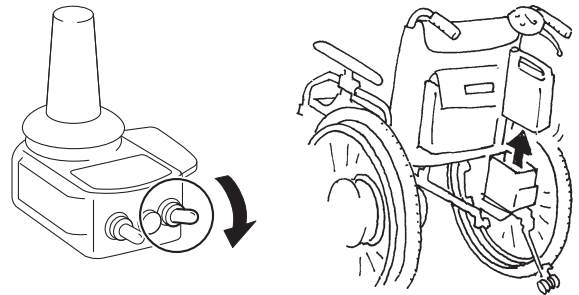

- (5) If the wheelchair will not be used for more than 3 months. See chapter 10.5.

10

### WARNING

Be sure to remove the battery when not in use, so that its power will not turn on unexpectedly in storage.

Be sure to store the disconnected battery with the protective cap on it. Exposed contacts can cause short circuits and lead to a fire or battery rupture.

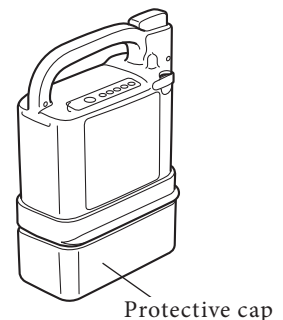

**TIP** When storing the battery for a long period of time, see sections below, and observe the cautionary notes.

- For the nickel metal hydride battery “8.2. (3) Storing the battery”
- For the lithium ion battery “9.2. (3) Storing the battery”

Please refer to the Warnings in “1.5.15. Transporting and Storing the Wheelchair” on page 23 to 25.

## 10.4. Boarding an Airplane

Once your plane trip has been determined, inform your airline company in advance, that you will be using an electric wheelchair, and follow their instructions. At this time, provide the airline company with details of your wheelchair. In particular, see the specifications for the battery you are using, below:

- Nickel metal hydride battery (shown as “Ni-MH” on the label)
  - Model JWB2
  - Voltage 24 V
  - Capacity 6.7 Ah
  - Type Dry cell with a built-in microcomputer
- Lithium ion battery (shown as “Li-ion 00” on the label)
  - Model ESB1
  - Voltage 25 V
  - Capacity 11.2 Ah (280 Wh)
  - Type Dry cell with a built-in microcomputer

### About the lithium ion battery

There may be restrictions in regard to carrying the lithium ion battery on-board, or checking-in as a baggage. Be sure to consult with the airline company in advance.

10

## 10.5. Long-term Storing the Wheelchair (longer than 3 Months)

- (1) Please check the wheelchair service manual for instructions how to store your wheelchair for a long period of time.
- (2) Before storing E-Drive PLUS for a long period of time, please
  - check the tire pressure. Please see page 101 for the values.
- (3) Before using your wheelchair and E-Drive PLUS after long term storage, please
  - check the status of your wheelchair according to the wheelchair service manual
  - check the tire pressure. Please see page 101 for the values.
  - place the battery in position
  - check that all cables are undamaged and connected

# 11. Using the Wheelchair more Comfortably

The E-Drive PLUS has a variety of features to improve its controllability. Use these features according to your purposes. For information on the wheelchair frame to which E-Drive PLUS is attached, see the owner's manual from the frame manufacturer.

## 11.1 Removing and Installing the Unit

The power units of the E-Drive PLUS can be removed from the frame when replacing the current wheels with manual wheels or when transporting the wheelchair.

### (1) Removing the power units from the frame

- 1 Turn off the power and remove the battery. Put the protective cap on the removed battery.

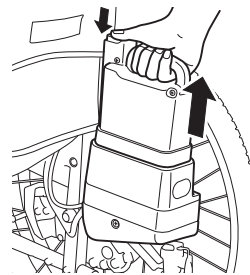
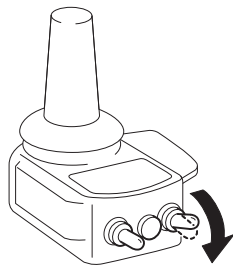

- 2 Switch the left and right clutches to the power drive position.

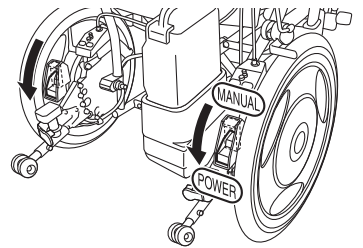
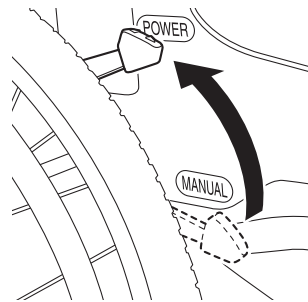

- 3 Turn the connector ring at the end of the cable counterclockwise while pulling the connector up to disconnect the cable.

Connector

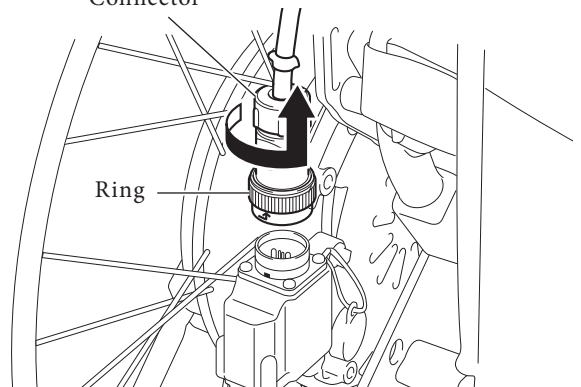

Ring

**TIP** On models that feature an integrated battery seat, the connector is located on the left wheel.  
On models that feature a detachable battery seat, a connector is located on both the left and right wheel.

- 4 Attach the cap to prevent dirt or water from entering the connector.

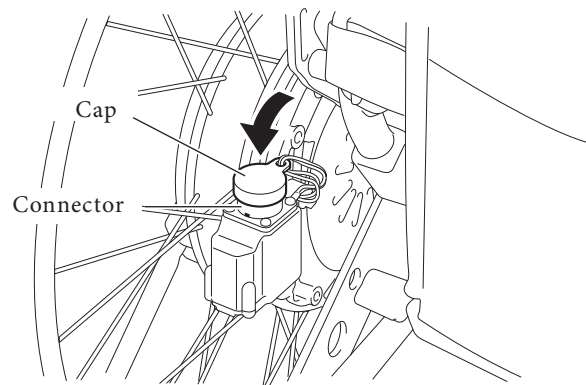

- 5 Place the wheelchair so that it will not become unstable when the power units are removed. (For example, as shown in the figure.)

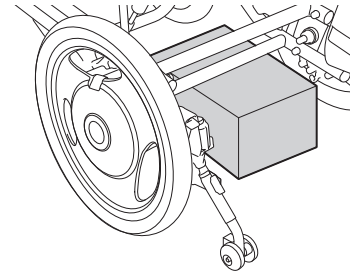

- 6 Release the parking brakes.

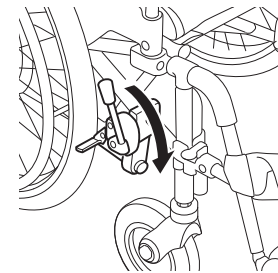

- 7 While holding the hub with both hands and pushing the middle of the center cap "a" with your fingers, pull out each power unit using both hands.

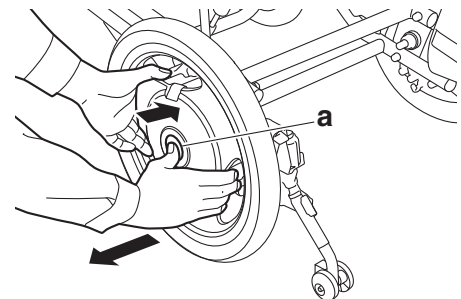

(2) Installing the power units to the frame

- 1 Place the wheelchair so that it will not become unstable. (For example, as shown in the figure.)

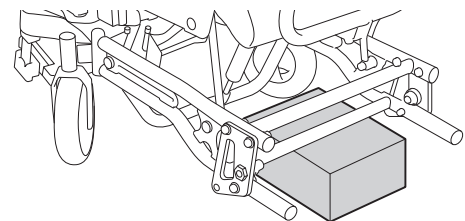

- 2 Switch the clutches on the units to the power drive position.

- 3 While pushing the middle of the center cap "a" with your fingers, install each power unit using both hands so that the torque stopper axle "b" fits into the torque-receiving component.

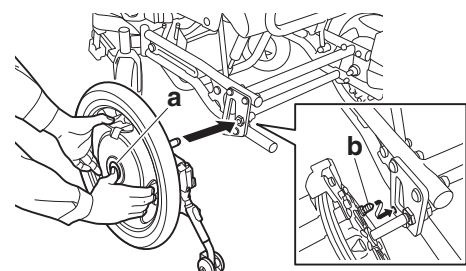

- 4 Push in each power unit completely. Check to ensure that the two balls “a” on the end of the axle can be seen completely.

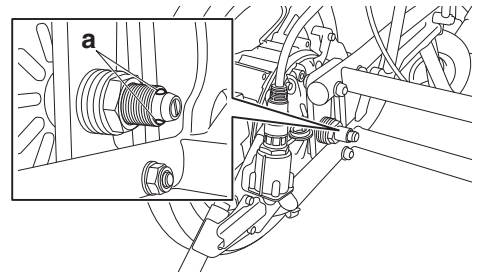

- 5 Pull each power unit to ensure that it will not come off.

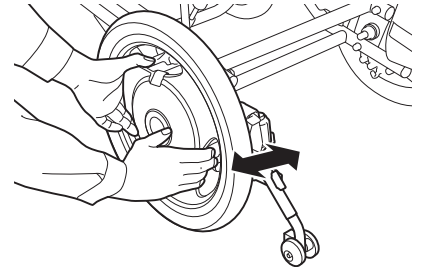

- 6 Place the power units in their normal position, and then apply the parking brakes.

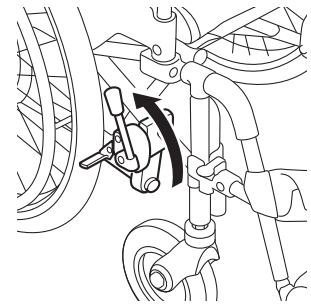

- 7 Remove the cap from the connector on the left wheel.

- 8 Align the white dot (arrow mark) on the connector at the end of the cable with the white dot on the connector on the wheel side, and then push in the cable connector until it clicks.

Connect the cable with an L mark to the connector with an L mark (on the wheel side), and connect the cable with an R mark to the connector with an R mark (on the wheel side).

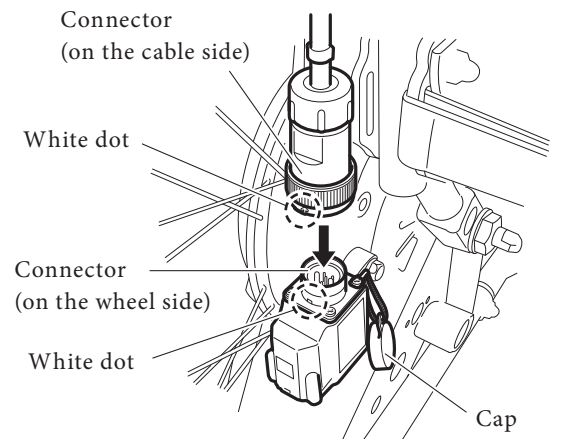

- 9 Make sure that the connector will not be disconnected.

#### NOTICE

When you install the right wheel on models that feature an integrated battery, support the battery storage compartment to prevent the wheel from turning. Otherwise, the wheel might turn, possibly causing damage to the switch or the battery storage compartment.

: Install the battery.

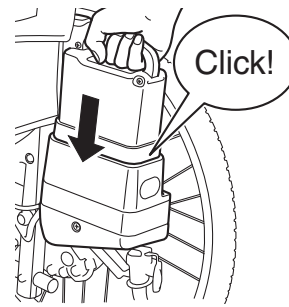

### **WARNING**

When a person is sitting in the wheelchair, do not remove or install the wheels. The person riding in the wheelchair or people around the wheelchair may get injured. After the power units are installed to the frame, be sure to check that the balls on the end of each axle can be seen, and that the units will not come off if pulled. If the axles are not secured, the axles could suddenly come off while the wheelchair is traveling and the wheelchair could tip over, causing serious injury.

## 11.2. Anti-tip Device

The anti-tip device of the E-Drive PLUS can be folded. Do so when going over bumps with the assistant operations. Immediately after going over a bump, return the anti-tip device to its original position.

### (1) Retracting the anti-tip device

Turn the anti-tip device inward while the lock lever is pushed.

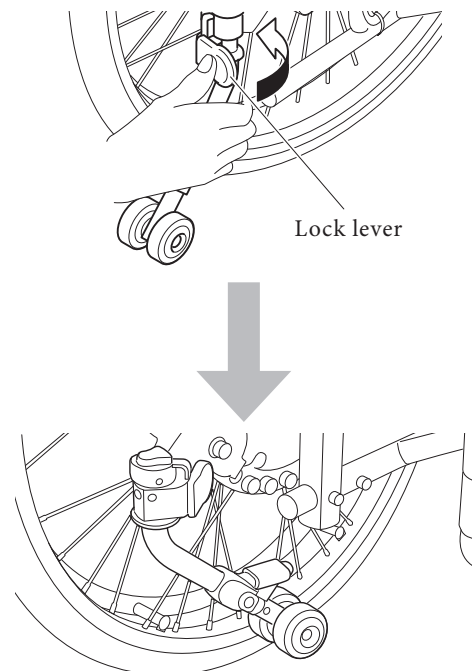

- (2) Returning the retracted anti-tip device to its original position

Turn the anti-tip device outward without touching the lock lever until you hear a click.

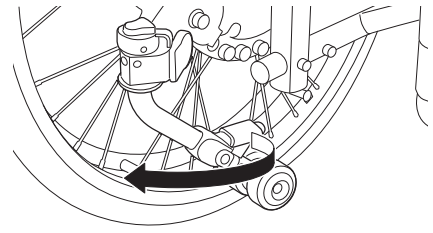

Make sure that the anti-lock device is locked in position.

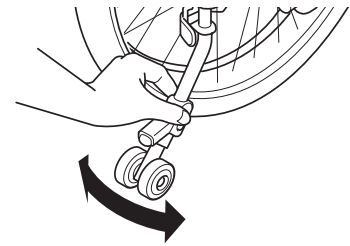

## WARNING

Operating the wheelchair when the anti-tip device is removed or not in the correct position may cause a rollover. Make sure you operate the wheelchair with the safety wheels facing downwards. Only have the safety wheels facing upwards when going over bumps with the assistant operations and other such situations.

Make sure you return the safety wheels to the correct position after going over the bump.

A road surface with large depressions can cause a rollover, even if the safety wheels are facing downwards. When going over bumps, also pay close attention to the condition of the road surface. Even if the anti-tip device is in the correct position, the wheelchair could rollover due to various factors, such as a bumpy road surface, holes, level differences, and slopes.

Make sure that the road you use frequently on a daily basis is safe beforehand.



## 11.3. Controller

### (1) Retracting the controller

The controller can be retracted. Retract the controller to move close to a table or desk.

#### 1 Horizontal-type controller holders

Turn off the power switch.

Turn the controller while the lock lever of the holder is pushed forward.

To return the controller to its original position, reverse the procedure.

Make sure that the controller is locked in position.

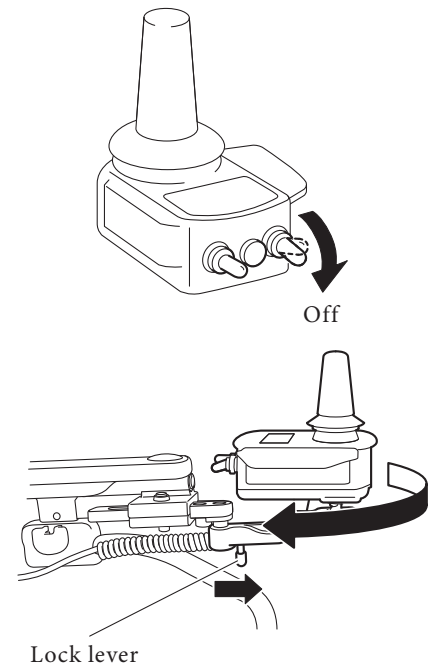

#### 2 Vertical-type controller holders

Turn off the power switch.

Move the upper holder lock lever outward.

Pull the controller upward to remove it.

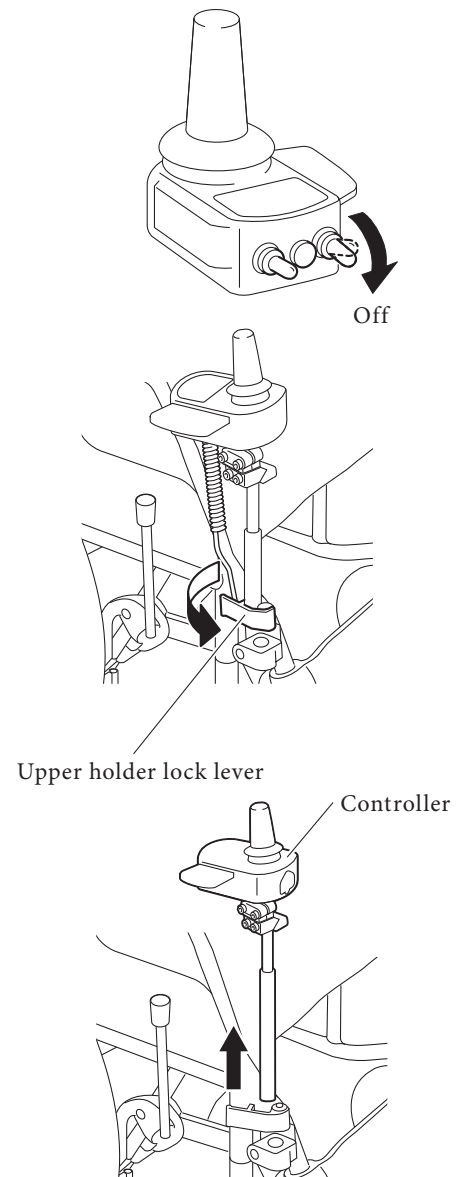

Insert the controller into the lower holder.

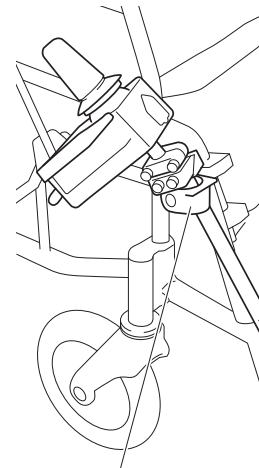

Lower holder

To return the controller to its original position, reverse the procedure.

### **WARNING**

Do not remove the controller from the upper holder with the power on, and do not turn on the power after removing it. The joystick may tilt, causing the wheelchair to move unexpectedly, and this may result in injury to you or other people in your surrounding area. Never travel in power drive mode with the controller removed from the upper holder. Also, do not remove the controller from the upper holder while traveling. You may not be able to control the wheelchair properly, and you or other people in your surrounding area may get injured.

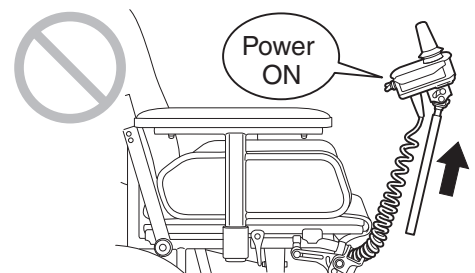

## 11

### (2) Adjusting the mounting position of the controller

The mounting position and angle of the controller can be adjusted. Consult with your dealer on this adjustment.

#### 1 Adjusting the position

[For vertical-type controller holders]

You can adjust the position up, down, to the left, or to the right. You can also adjust the height.

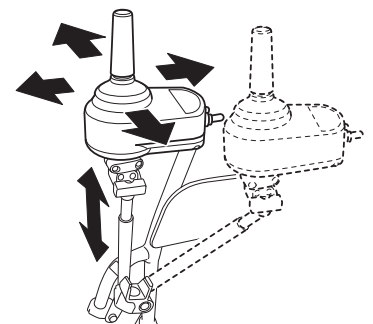

[For horizontal-type controller holders]

You can adjust the position to the front, rear, left, or right.

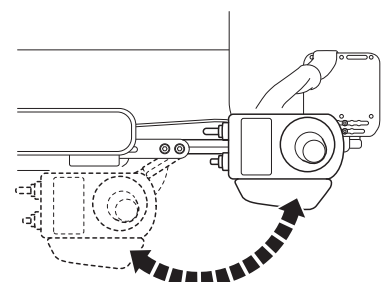

## 2 Adjusting the angle

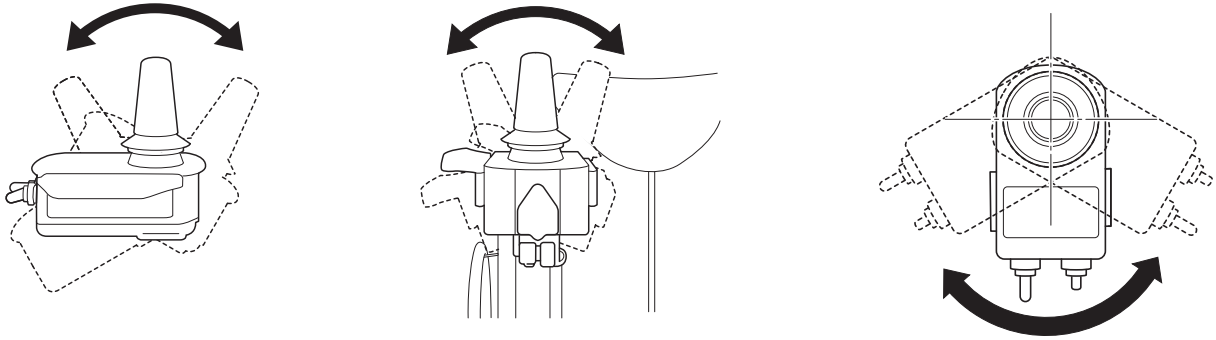

You can adjust the forward, backward, left and right tilt and the direction of the controller.

## (3) Adjusting the heaviness of the joystick on the controller

The heaviness of joystick can be adjusted.  
Request this adjustment to your dealer.

The operation load when the unit was shipped from the factory is 2.0 Nm (0.2 kg). By replacing the spring with a spring sold separately, the load can be changed to 0.5 Nm (0.05 kg), 0.9 Nm (0.09 kg), or 5.0 Nm (0.5 kg). However, some of the springs cannot be used depending on the type of joystick.

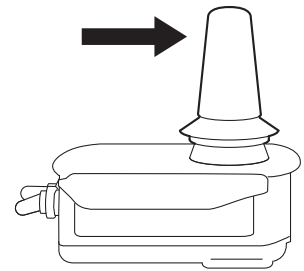

## (4) Replacing the joystick

The joystick can be replaced to any of the 6 sold separately. Consult with your dealer on replacement.

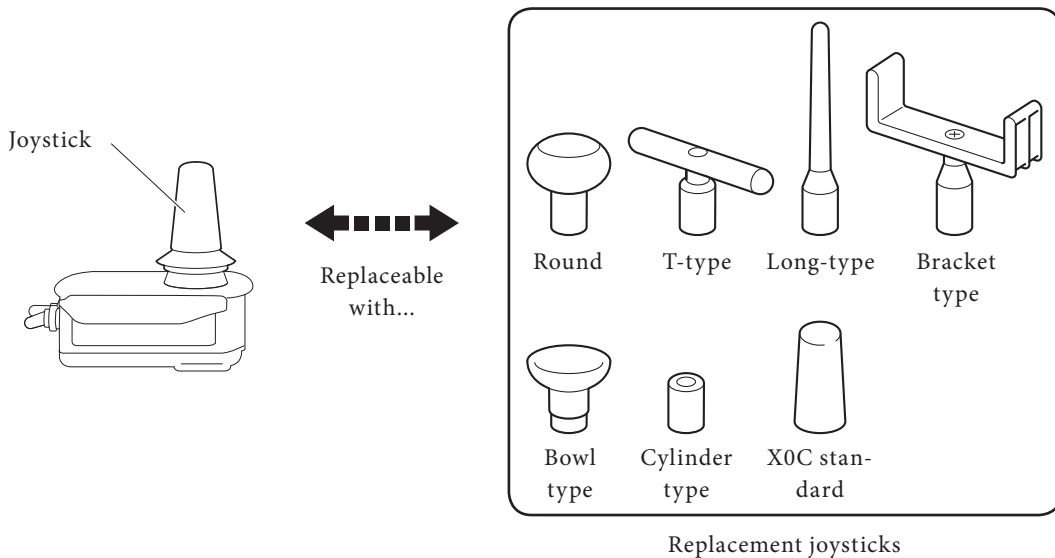

(5) Retracting the controller with the horizontal-type holders.

The controller can be retracted. Retract the controller to move close to a table or desk.

Turn off the power switch.

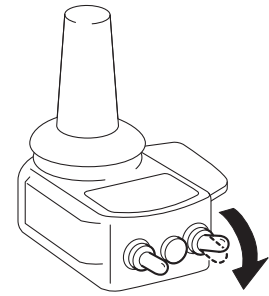

Turn the controller while the lock lever of the holder is pushed forward.

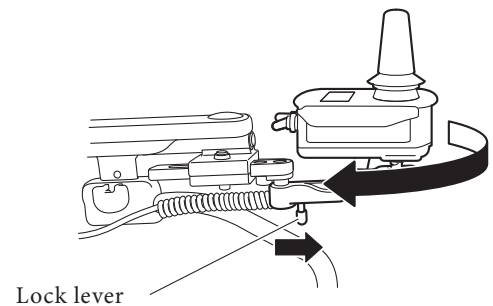

To return the controller to its original position, reverse the procedure.

Make sure that the controller is locked in position.

Alternately, you can pull out the controller from the holder while pulling the lock lever of the controller "a".

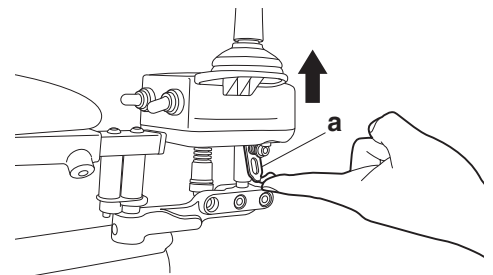

 **WARNING**

Do not retract or pull out the controller from holder with the power on, and do not turn on the power after retracting or pulling out it. The joystick may tilt, causing the wheelchair to move unexpectedly, and this may result in you or other people in your surrounding to getting injured. Never travel in power drive mode with the controller retracted or pulled out. Also do not retract or pull out the controller while traveling. You may not be able to control the wheelchair properly, and you or other people in your surrounding may get injured.

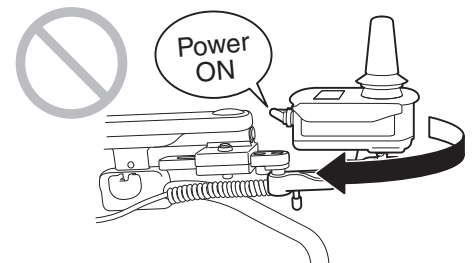

## 11.4. Assistant Controller (Optional)

The mounting angle of the assistant controller can be adjusted.  
Consult with your dealer on this adjustment.

### 3-step adjustment

You can adjust the angle in the direction of the arrow.

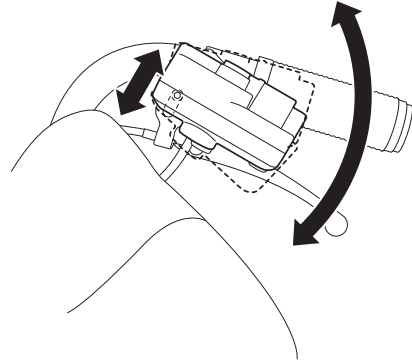

## 11.5. Clutch Levers

The mounting angle of the clutch levers can be adjusted.  
Consult with your dealer on this adjustment.

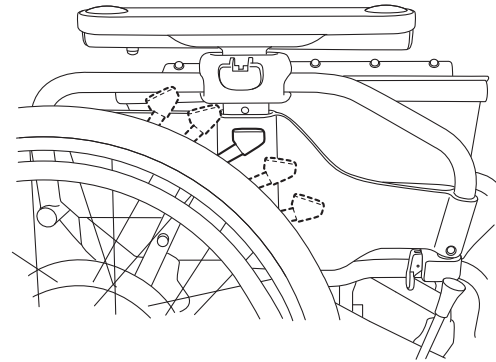

## 11.6. Parameter Settings

The settings of the features and characteristics of the E-Drive PLUS can be changed to fit your usage. These changes are performed by changing the “parameter settings”. Consult with your dealer on changing the parameter settings.

There are two parameter settings: “Functional Parameters” and “Driving Parameters”.

### (1) Functional Parameters

#### 1 Auto power off function

This is a function that turns off the power after a specified time of non-operation.

Setting 1.....The power turns off if the joystick has not been operated for 10 minutes. (Default setting)

Setting 2.....The power turns off if the joystick has not been operated for 60 minutes.

Setting 3.....The power does not turn off automatically.

## 2 Buzzer sound

This function is for sounding a buzzer when the power is turned on, or when an error such as disengaged clutches occurs.

Setting 1.....The buzzer sound is enabled. (Default setting)

Setting 2.....The buzzer does not sound when the power is turned on, the maximum speed is adjusted, the controller is operated with the clutch levers in the manual position, etc.

It is impossible to disable the horn and alert sounds.

## 3 LCD brightness

This function sets the brightness of the LCD of the controller.

Setting 1.....Normal brightness setting (Default setting)

Setting 2.....Slightly darker setting

Setting 3.....Dark setting

## 4 Electromagnetic brake operation timing selection

This function adjusts the time until the electromagnetic brake is applied after the wheelchair stops.

Setting 1.....The electromagnetic brake is applied 10 seconds after the wheelchair stops. (Default setting)

Setting 2.....The electromagnetic brake is applied immediately after the wheelchair stops.

## (2) Driving Parameters

You can adjust settings such as speed, acceleration, and joystick sensitivity.

### 1 Preset mode

Select from 3 preset modes.

Setting 1.....Soft mode

Setting 2.....Normal mode (Default setting)

Setting 3.....Sports mode

### 2 Free mode

You can make fine adjustments to settings, such as speed, acceleration, joystick sensitivity, and joystick input direction switching.



## WARNING

When evaluating the need to change parameter settings and choosing the actual changes, consult the guidance of experts, such as physical therapists and occupational therapists, and have your dealer make the changes.

## 11.7. Smart Tune Settings

The settings of the features and characteristics of E-Drive PLUS can be changed to fit your usage. These changes are performed by changing the “parameter settings” with using PC and the Smart Tune software. Consult with your dealer on changing the parameter settings.

There are two parameter settings: “Functional Parameters” and “Driving Parameters”.

### (1) Functional Parameters

#### 1 Auto power off function

This is a function that turns off the power after a specified time of non-operation.

Setting 1..... The power turns off if the joystick has not been operated for 10 minutes. (Default setting)

Setting 2..... The power turns off if the joystick has not been operated for 60 minutes.

Setting 3..... The power does not turn off automatically.

#### 2 Buzzer sound

This function is for sounding a buzzer when the power is turned on, or when an error such as disengaged clutches occurs.

Setting 1..... The buzzer sound is enabled (Default setting)

Setting 2..... The buzzer does not sound when the power is turned, maximum speed is adjusted, when operated with the clutch levers in manual position, etc.

It is impossible to disable the horn and alert sounds.

#### 3 LCD brightness

This function sets the brightness of the LCD of the controller.

Setting 1..... Normal brightness setting (Default setting)

Setting 2..... Slightly darker setting

Setting 3..... Dark setting

#### 4 Electromagnetic brake operation timing selection

This function adjusts the time until the electromagnetic brake is applied after the wheelchair stops.

Setting 1..... The electromagnetic brake is applied 10 seconds after the wheelchair stops. (Default setting)

Setting 2..... The electromagnetic brake is applied immediately after the wheelchair stops.

(2) Driving Parameters

You can adjust settings such as speed, acceleration, and joystick sensitivity.

1 Preset mode

Select from 3 preset modes.

Setting 1..... Soft mode

Setting 2..... Normal mode (Default setting)

Setting 3..... Sports mode

2 Free mode

You can fine-adjust such settings as the speed, acceleration, motor torque.



**WARNING**

When evaluating the need to change parameter settings, and choosing the actual changes, consult the guidance of experts such as physical therapists and occupational therapists at the dealer.



# 12. Maintenance, Daily Check, Periodic Inspection

It is recommended that the E-Drive PLUS be inspected periodically at the dealer. (Inspection is fee-based)

To ensure long-term durability, we recommend that you perform regular inspections every 12 months after initial use.

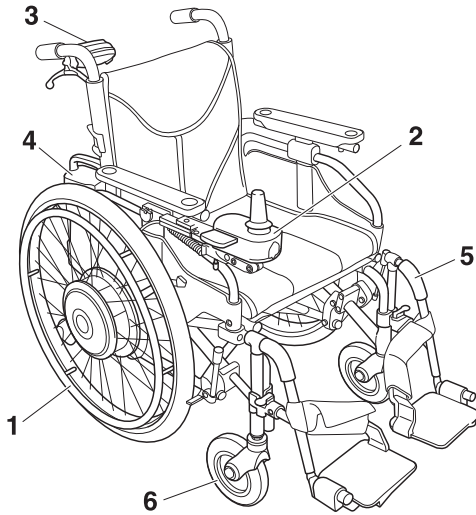

Inspection area

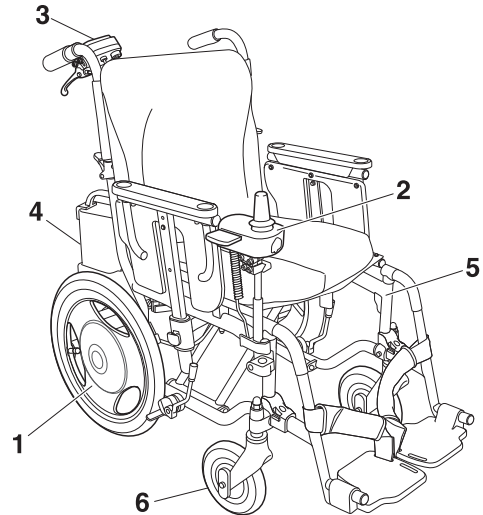

## Sample Inspection Form

Inspection Item		Date of Inspection	Inspection Area	Checked	Corrective Measure
1	Unit		Noise, jammed object		
			Tire air pressure (24" model: 450 kPa, 4.5 kg/cm <sup>2</sup> , 16" model: 350 kPa, 3.5 kg/cm <sup>2</sup> ), wear, cracks, loose valve, cap		
			Hand rim looseness, damage, harmful damage, burrs, sharp points, and so on		
			Spoke looseness, breakage		
			Torque stop tightening		
			Dust cover installation		
			Anti-tip device looseness, deformation, damage		
			Dirty terminals on battery seat		
			Clutch operation, clutch cable damage		
			Wire connection looseness, damage		
2	Controller		Damage, deformation, looseness, harmful damage, burrs, sharp points, and so on		
			Power switch, speed selector switch operation		
			Rubber cap damage		
			Joystick operation, actually move the joystick and make sure that it operates correctly.		
			Wire routing, damage		
3	Assistant controller (optional)		Damage, looseness, harmful damage, burrs, sharp points, and so on		
			Power switch, speed adjustment dial operation		
			Rubber cap damage		
			Brake lever play, effectiveness, squeal		
			Brake cable, wire routing, damage		
	Actually operate the controller and make sure that it operates correctly.				
4	Battery and charger		Loose bolts, damage, use condition, charging frequency, refresh status		

Inspection Item		Date of Inspection	Inspection Area	Checked	Corrective Measure
5	Frame (example) or (reference)		Deformation, damage, bolt looseness, harmful damage, burrs, sharp points, and so on		
			Folding function		
			Creaking sound		
			Footrest looseness		
			Parking brake effectiveness, wear		
6	Casters (example) or (reference)		Air pressure (for pneumatic tires)		
			Wear, cracks		
			Looseness, wobbles, noise		
			Twisted valve stem, cap (for pneumatic tires)		
7	Battery bag		Fray, wear and tear, or damage		
			Fray, damage, or foreign material on the straps, belt, or the cable fasteners on the bag		
			Looseness or slack in the upper straps and lower belt		
			Pinched if the wheelchair is folded		
			Caught or touched by moving parts		

**! WARNING**

Continuing to use the wheelchair with a problem in the wheelchair body or the wheels may cause damage to the wheelchair while traveling, and may result in a rollover or fall.

## 12.1. Maintenance

### [Cleanup]

If the E-Drive PLUS becomes dirty due to normal use, use a tightly wrung-out towel to wipe off any dirt. If the dirt is excessive, use a towel and neutral detergent to remove the dirt. After removing the dirt, be sure to wipe off any remaining detergent.

Do not wash by directly hosing it down with water. Also, do not wash using steam. The electronic devices can get damaged, which may lead to malfunction.

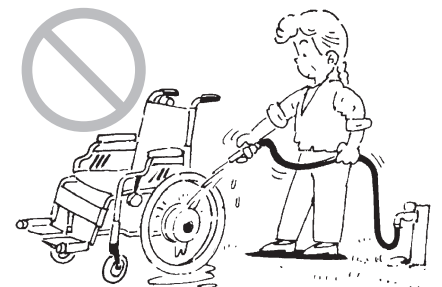

Do not clean with solvent such as gasoline or paint thinner. This may damage the painting and plastic parts.

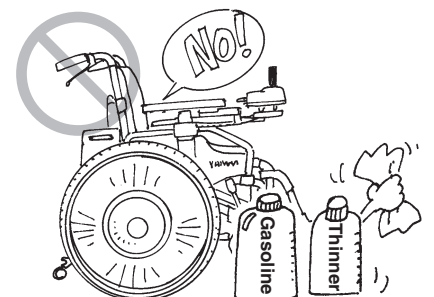

When disinfecting the wheelchair, remove the E-Drive PLUS from the frame, and then disinfect only the frame. Have the dealer remove the E-Drive PLUS from the frame. To disinfect the E-Drive PLUS, do not heat, pressurize, depressurize, supply electricity, irradiate with electromagnetic waves, immerse in a liquid, or apply a liquid cleaner or spray. Instead, wipe the E-Drive PLUS using a towel and alcohol.

#### [Easy repairs]

The rubber covers (yellow “a” and black “b”) for the controller switches and the rubber covers “c” at the centers of the wheels can be installed easily without tools. The switch rubber covers are a screw-on type. If the rubber covers are damaged or lost, contact the dealer for replacements. If you continue to use the controller when these parts are damaged or not installed, dust or water could enter the controller and cause it to malfunction.

When new parts are installed, ensure that they are installed securely and operate correctly before using the wheelchair.

To purchase a new battery, contact the dealer.

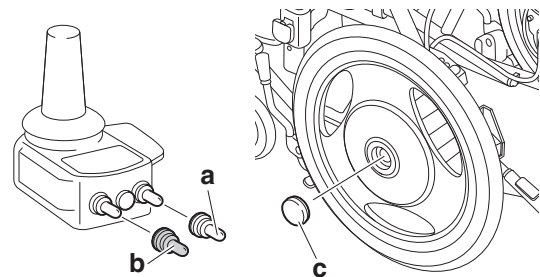
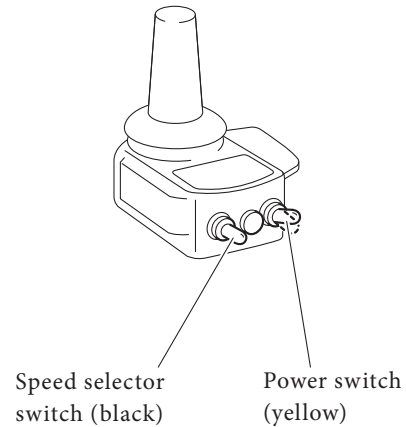

#### [Normal repairs]

If other parts are damaged or lost, immediately contact the dealer. Have the dealer replace the parts or repair the wheelchair.

For normal maintenance, repairs, or service, be sure to contact the dealer. The user should not repair or service the wheelchair, or remove, pack, and send the parts to request repairs. If the wheelchair is not repaired or assembled completely, the user or those around the user could be injured.

To perform repairs and service, the dealer uses the service manual, parts catalog, and other documentation. These items are not sold to the general public.

When requesting repairs, do not send the wheelchair directly. First, contact the dealer.

The estimated life of the E-Drive PLUS is 5 years. Parts that are necessary for repairs will be available for 5 years after the production of the E-Drive PLUS has ended.

In addition, a substitute wheelchair will not be provided during repairs or inspections.

You must pay for repairs that are not covered by the warranty.

## 12.2. Daily Checks

Perform the following checks every day before operating the wheelchair. For details, refer to “3.1. Inspecting the Wheelchair”.

- |   |                 |  |
|---|-----------------|--|
| 1 | Exterior        | Visually check the components and ensure that they are not damaged.  |
| 2 | Anti-tip device | Make that the anti-tip device is in the correct position and locked in place.  |
| 3 | Rear tires      | Make sure that there is tire depth, there are no cracks, and there is sufficient air pressure.<br>If the pressure is not enough, pump up to 4,5 Bar for E-Drive PLUS 24" or 3,45 Bar for E-Drive PLUS 16". |
| 4 | Parking brakes  | Make sure that the parking brakes can stop the wheels from moving, and that they are installed securely to the frame.  |
| 5 | Wheels          | Make sure that the wheels are not deformed and the spokes are not broken.  |
| 6 | Casters         | Make sure that there is tire depth, and there are no cracks.<br>Make sure that the caster forks are not damaged.<br>Make that the nuts securing the tires are not loose.                                   |
| 7 | Battery         | Check the residual capacity.   |

If any problems are found, have the dealer repair the wheelchair.

## 12.3. Quit to Use E-Drive PLUS and Recycling

When you quit to use and quit hold of E-Drive PLUS, for recycling, contact your local government first and follow their instructions. Or contact your dealer.

# 13. Dimensions and Specifications

Model			Electric Power Unit for Wheelchairs		
			E-Drive PLUS 24"		E-Drive PLUS 16"
Weight	Total Weight (without assistant controller)	with battery	Nickel metal hydride battery	18 kg	17 kg
			Lithium ion battery	19 kg	18 kg
	without battery			15 kg	14 kg
	Part weight		Right unit	7.5 kg	7 kg
			Left unit	6.5 kg	6 kg
			Controller	1 kg	
			Assistant controller	1 kg	
			Ni-MH battery	3 kg	
		Li-ion battery	4 kg		
Tire size			22"	24"	16"
Rear Tire	Tire specifications		37-501 (22x1 3/8)	37-540 (24x1 3/8)	47-305 (16x1 6/8)
	Recommended air pressure		4,5 Bar	4,5 Bar	3,45 Bar
Drive motor			AC servomotor 24V 120W x 2 (30minutes rated output)		
Drive system			Rear wheel direct drive		
Brake system			Motor generative brake + Electromagnetic brake		
Steering system			Joystick steering		
Control system			Microprocessor control		
Minimum Reversing Space width			Varies depending on the wheelchair the unit is installed on. Pivoting on a spot is possible. *1		
Rated slope			6 degree		
Maximum height of curbs that can be gone over			25 mm		
Maximum width of ditches that can be gone over			Varies depending on the wheelchair the unit is installed on and the caster size.		
Operating conditions	environment		Inside and outside		
	temperature		0°C to 35°C		
	humidity		No condensation		
IEC waterproof standard			IPX4 (resistance against splashing water)		
Load capacity (including the rider, luggage, and frame weight)			125 kg *2		100 kg *2
Travel range	Continuous travel range (in accordance with Yamaha spec)	with Ni-MH battery (JWB2)	16 km *3		15 km *3
		with Li-ion battery (ESB1)	30 km *3		25 km *3
Travel speed	Controller (5-stge adjustment)	Forward	1.7-6.0 km/h		1.7-5.7 km/h
		Backward	1.0-3.0 km/h		0.9-2.8 km/h
	Assistant controller	Forward	1.4-5.0 km/h		
		Backward	0.5-2.0 km/h		

\*1 Minimum Reversing Space is the space required to pivot on a spot and is determined by the wheelchair frame.

Minimum Reversing Space Width

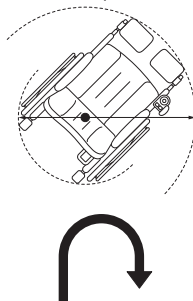

\*2 The value is the load capacity for the E-Drive PLUS. When the wheelchair is completely assembled, the total weight of the rider and luggage must not exceed the load capacity of the wheelchair frame.

If the wheelchair is operated continuously with a load that exceeds this value, the product could malfunction or be damaged, or its life could be shortened.

\*3 The travel range varies depending on the conditions of the road surface (travel over curbs, on slopes, and so on) and may be shorter than this value.

Battery and Charger		Nickel-Metal Hydride	Lithium-ion
Battery	Model	JWB2	ESB1
	Type	Rechargeable Dry Battery with built in microprocessor	
	Nominal output voltage	24 V	25 V
	Rated output (5-hour rate)	6.7 Ah (160.8 Wh)	11.8 Ah (280 Wh)
Battery Charger	Model	JWC-2	ESC1
	Charging method	Automatic Charging controlled by the microprocessor	
	Rated output during charging	29 V · 2.6 A	29.2 V · 3 A
	Chargeable battery	JWB2 *4	ESB1 *4
	Charging time	Time for normal charging	2.5–3.5 hr
Time for refresh charging		3–13 hr	—

\*4 The Ni-MH battery and Li-ion battery each have a dedicated charger. The dedicated chargers are not interchangeable.

# 14. Troubleshooting

If you have flat tires, contact your dealer. The tire structure of E-Drive PLUS is same to bicycle tires. Most of cycle shops can repair the flat tires.









## 14.1. Before Requesting Repairs

Check the following troubleshooting tables.



### When Operating the Wheelchair

Problem	LCD Indication	Buzzer	Check Point	What to Do
The wheel-chair does not start moving, or stops while traveling.		Beeps (Pi Pi) (4 times)	Are the clutch levers in the manual drive position?	Shift the clutch levers to the power drive position.
		Beeps (Pi —)	Has the battery run down?	Charge the battery. If there are no problems with the battery, contact your dealer.
			Do you use a lithium ion battery, and are you operating the wheelchair in a place where the ambient temperature is below the freezing point, or in the scorching heat of summer? Additionally, was the wheelchair stored in a place where the ambient temperature dropped below the freezing point, or where the temperature became hot, such as inside a car?	Switch to manual operation.
			Is the battery properly inserted?	Insert the battery properly.
			When operated by the rider, is the assistant controller turned on?	In this case, turn off the power switches on both controllers, and turn on the power for the controller.
			When operated by the assistant, is the controller turned on?	In this case, turn off the power switches on both controllers, and turn on the power for the assistant controller.
		Beeps (Pi —)	Are you turning on the power while the joystick is tilted?	Bring the joystick to the neutral position, turn off the power, and then turn it back on again. If the problem is not resolved, contact your dealer.
			Has the power been turned off automatically by the auto power off function?	Turn off the power, and then turn it back on again.
		Beeps (Pi —)	Has the motor overheated as a result of abusive riding?	Turn off the power. Wait a while before resuming the ride.

Problem	LCD Indication	Buzzer	Check Point	What to Do
Unable to operate			Are the brakes engaged on the wheelchair?	Release the brakes.
			Is the anti-tampering function turned on?	Turn off the anti-tampering function.
		Beeps (Pi —)	Are the controller and assistant controller operating?	Contact your dealer.
Shortage of power		Beeps (Pi —) repeatedly	Is there a large load being applied?	It will stop beeping once the load is reduced.
		Beeps (Pi) repeatedly	Is there a large load being applied, causing the motor to overheat?	Lighten the load so that the motor will not overheat.
			Is the ambient temperature low? Is the battery stored in a place where the temperature becomes hot, such as inside a car?	The battery power decreases when the battery temperature is $-5^{\circ}\text{C}$ or lower or $60^{\circ}\text{C}$ or higher. Wait until the battery reaches an appropriate temperature.
			Has the battery deteriorated?	Replace with a new battery. For a nickel metal hydride battery, try refresh charging.
		Beeps (Pi Pi Pi Pi) (4 times)	Is the battery residual capacity sufficient?	Promptly move to a safe place, turn off power and charge the battery, or replace with a spare battery (sold separately).
Buzzer sounds continuously		Beeps (Pi Pi — Pi Pi —) repeatedly	Is the anti-tip device retracted?	Extend the anti-tip device.
Short travel range, or insufficient speed			Is the battery sufficiently charged?	Replace with a new battery. For a nickel metal hydride battery, try refresh charging.
			Is the ambient temperature low?	The battery power decreases when the temperature drops.
			Is the wheelchair carrying heavy loads or driving uphill?	Heavy loads tend to shorten the travel range.
			Is the speed parameter set to the standard setting?	Contact your dealer.
Sluggish manual travel			Is the speed setting set to a low speed setting?	Adjust it to a higher speed setting.
			Is the air pressure of the tires too low?	Inflate the tires.
Assistant brakes do not work			Are the brakes engaged on the wheelchair?	Release the brakes.
Assistant brakes pull to one side			Does the brake lever have too much play?	Contact your dealer.
Brakes squeal			Are both brakes adjusted evenly?	Contact your dealer.
			Are the brake drums damaged or are the brake shoes worn out?	Contact your dealer.
			Have the brakes been applied for a long time?	The brakes can make a noise depending on how they are applied, but this is not abnormal.



Problem	LCD Indication	Buzzer	Check Point	What to Do
Abnormal vibration or noise			Is the area where the axle is mounted loose?	Tighten it or contact your dealer.
			Is there noise coming from the drive unit?	Contact your dealer.
			Is the wheelchair frame or front casters wobbling?	Contact your dealer.

### When Charging (Ni-MH Nickel Metal Hydride Battery)

Problem	Charger LED Indication	Battery LED Indication	Check Point	What to Do
Will not charge	Off	Off	Is the power cord connected?	Connect the power cord to a power source.
	Off	Off	Will another battery accept a charge?	If another battery cannot be charged, replace the charger.
	Flashing green and red alternately	Off	Is the battery fuse blown?	Contact your dealer.
	Flashing green and red alternately	Off	Will another battery accept a charge?	Replace the charger.
	Off	Off	Will another battery accept a charge?	The charger is normal if it can charge. Replace the battery.
Prolonged charge standby	Flashing green	Residual capacity indicator lamps are lit	Is the battery temperature appropriate?	Wait until the battery reaches an appropriate temperature.
	Flashing green	Residual capacity indicator lamps are lit	Is the ambient temperature appropriate?	Charge the battery in an environment with an appropriate temperature (cool in the summer and warm in the winter).
Stops charging halfway	Off	Residual capacity indicator lamps are lighted only halfway	Is the temperature of the battery high?	After the battery has cooled down, try charging again.
Takes too long to charge	Lit orange	Residual capacity indicator lamps are lit, and then turned off successively	Are you refresh charging the battery?	The battery is being discharged. Refresh charging will take 3 to 13 hours.
After charging is completed, all of the lamps are not lit		Residual capacity indicator lamps are lighted only halfway	Check the number of times or days you have used the battery.	Has the battery deteriorated? After approximately 300 charge/discharge cycles, the battery capacity will decrease to approximately 60% of that of a new battery.
The charger emits a sound	Lamp display varies with the conditions.	Residual capacity indicator lamps are lit	Is there a sound of the cooling fan turning?	The charger is being cooled. The fan may turn or stop depending on the condition of the charger.

Problem	Charger LED Indication	Battery LED Indication	Check Point	What to Do
The charger gets unusually hot	Lamp display varies with the conditions.	Residual capacity indicator lamps are lit	Is there a sound of the cooling fan turning?	The charger temperature can get as high as 50°C, but this is normal as long as the cooling fan is operating. If the cooling fan is not operating, contact your dealer.
The charger emits an odor	Lamp display varies with the conditions.	Residual capacity indicator lamps are lit	Does this occur immediately after you start using the charger?	The charger may emit an odor immediately after it is put to use, but the odor will disappear eventually. If the odor persists, stop using the charger. The charger may be malfunctioning. Contact your dealer.

### When Charging (Li-ion 00 Lithium Ion Battery)

Problem	Charger LED Indication	Battery LED Indication	Check Point	What to Do
Will not charge	Off	Off	Is the power cord connected?	Connect the power cord to a power source.
	Lit red	Off		The battery may be malfunctioning. Contact your dealer.
	Flashing red	Off	Does the symptom persist after reconnecting the battery and the charger?	If the same phenomenon occurs after reconnecting with the battery, the battery may be malfunctioning. Contact your dealer.
Prolonged charge standby	Flashing green	Residual capacity indicator lamps are lit	Is the battery temperature appropriate?	Wait until the battery reaches an appropriate temperature.
	Flashing green	Residual capacity indicator lamps are lit	Is the ambient temperature appropriate?	Charge the battery in an environment with an appropriate temperature (cool in the summer and warm in the winter).
The charger gets hot	Lamp display varies with the conditions.	Residual capacity indicator lamps are lit		The charger temperature can get as high as 50°C, but this is not abnormal.
The charger emits an odor	Lamp display varies with the conditions.	Residual capacity indicator lamps are lit	Does this occur immediately after you start using the charger?	The charger may emit an odor immediately after it is put to use, but the odor will disappear eventually. If the odor persists, stop using the charger. The charger may be malfunctioning. Contact your dealer.
Battery gets very hot	Lamp display varies with the conditions.	Residual capacity indicator lamps are lit		Immediately stop charging and contact your dealer.

## 14.2. Requesting Repairs and Inspections

For your inspection, repair, and service needs, contact the dealer from which you purchased E-Drive PLUS. When contacting the dealer, your product serial number may be required. Refer to below to check the serial number, and provide it to the dealer.

Sales dealer:

## 14.3. Serial Number Location

The serial number is shown on the bottom of the battery seat.

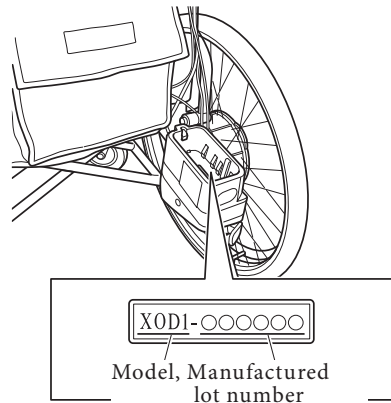

## 14.4. Warranty

The warranty period for the E-Drive PLUS is 2 year from the date of purchase.

During this warranty period, if there is a material or manufacturing defect in the E-Drive PLUS that you have purchased, the defective parts will be replaced or repaired free of charge. The warranty covers the power unit, controller, assistant controller, and charger. Consumable parts, such as the battery, tires, and tubes, are excluded from this warranty.

This warranty does not cover malfunctions due to either the user's intentional misuse or negligent use, such as malfunctions that are caused by use other than that specified in this owner's manual. This warranty also does not cover malfunctions due to modification of the unit or continuous use under conditions other than the specified conditions, such as exceeding the maximum weight etc., regardless of the cause of the malfunction.

Scratches, dullness, and dirt on the surface of the product through normal use are not included in the warranty.

If warranty repairs are necessary, contact the dealer where you purchased the unit.

## 14.5. Product Safety Notice and Product Recall Information

**Decon is keeping records of used components and assigned serial numbers. In the rare case of safety notice and/or product recall, Decon is able to contact the national distributor or final retailer. They will then be able to contact and inform the end user about any measures to be taken.**

Decon Wheel AB  
Södra Ekeryd 119, SE-314 93  
Hyltebruk Tel: +46 (0)345 40880  
Fax: +46 (0)345 40895  
[info@decon.se](mailto:info@decon.se)  
[www.decon.se](http://www.decon.se)

